

INFINITE ITERATED CROSSED PRODUCTS  
OF HOPF ALGEBRAS, DRINFELD DOUBLES  
AND PLANAR ALGEBRAS

*By*

SANDIPAN DE

MATH10201004007

The Institute of Mathematical Sciences, Chennai

*A thesis submitted to the*

*Board of Studies in Mathematical Sciences*

*In partial fulfillment of requirements*

*for the Degree of*

DOCTOR OF PHILOSOPHY

*of*

HOMI BHABHA NATIONAL INSTITUTE



May, 2016

# Homi Bhabha National Institute

## Recommendations of the Viva Voce Committee

As members of the Viva Voce Committee, we certify that we have read the dissertation prepared by Sandipan De entitled “Infinite iterated crossed products of Hopf algebras, Drinfeld doubles and planar algebras” and recommend that it may be accepted as fulfilling the thesis requirement for the award of Degree of Doctor of Philosophy.

---

Chairman - V. S. Sunder

Date: May 6, 2016

---

Guide/Convenor - Vijay Kodiyalam

Date: May 6, 2016

---

Examiner - Shamindra Kumar Ghosh

Date: May 6, 2016

---

Member 1 - Parameswaran Sankaran

Date: May 6, 2016

---

Member 2 - S. Viswanath

Date: May 6, 2016

Final approval and acceptance of this thesis is contingent upon the candidate's submission of the final copies of the thesis to HBNI.

I hereby certify that I have read this thesis prepared under my direction and recommend that it may be accepted as fulfilling the thesis requirement.

**Date: May 6, 2016**

**Place: Chennai**

Guide

## STATEMENT BY AUTHOR

This dissertation has been submitted in partial fulfillment of requirements for an advanced degree at Homi Bhabha National Institute (HBNI) and is deposited in the Library to be made available to borrowers under rules of the HBNI.

Brief quotations from this dissertation are allowable without special permission, provided that accurate acknowledgement of source is made. Requests for permission for extended quotation from or reproduction of this manuscript in whole or in part may be granted by the Competent Authority of HBNI when in his or her judgement the proposed use of the material is in the interests of scholarship. In all other instances, however, permission must be obtained from the author.

Sandipan De

## DECLARATION

I, hereby declare that the investigation presented in the thesis has been carried out by me. The work is original and has not been submitted earlier as a whole or in part for a degree / diploma at this or any other Institution / University.

Sandipan De

## List of publications arising from the thesis

### Journal

1. Note on infinite iterated crossed products of Hopf algebras and the Drinfeld double, Sandipan De and Vijay Kodiyalam, Journal of Pure and Applied Algebra, 2015, 219 Vol. 12, 5305 - 5313.

Sandipan De

## DEDICATIONS

*'Hari Om Tat Sat'*

*To my family who have always prayed for me*

## ACKNOWLEDGEMENTS

It is my great pleasure to express my heartfelt gratitude to all those who helped and encouraged me at various stages of Ph.D.

I am indebted to my advisor Prof. Vijay Kodiyalam for his invaluable guidance and unconditional support. Whenever any doubt/question has arisen in mind, both mathematical and non-mathematical, he has always been there to listen to me with immense patience and shown the right path. Without him, my thesis would not have seen the light of the day.

I would like to thank Prof. V.S. Sunder for helpful discussions and encouragement.

I thank all the academic, administrative and technical members of The Institute of Mathematical Sciences, Chennai for giving a conducive environment to pursue research.

I thank my friends Sumit, Chandan, Arghya, Kamalakshya, Issan and Anbu who made my life easier during these years with wonderful companion and lively discussions both mathematical and non mathematical. I thank my office mates for creating a wonderful office environment. I thank my friends for keeping my spirits high throughout, and for several helpful discussions.

My heartfelt thanks to my friends Saranya and Soumenu for their emotional support and practical help.

Finally, I am forever indebted to my family for their unconditional love, care, support and encouragement.

# Contents

<b>Synopsis</b>	<b>10</b>
<b>List of Figures</b>	<b>13</b>
<b>1 Hopf algebras</b>	<b>16</b>
1.1 Hopf algebras . . . . .	16
1.2 Integrals . . . . .	23
1.3 Semisimple Hopf algebras . . . . .	26
<b>2 Planar algebras</b>	<b>30</b>
2.1 Planar tangles and operations on tangles . . . . .	30
2.2 Some examples of tangles . . . . .	32
2.3 Planar algebras . . . . .	33
2.4 Universal planar algebras and presentations . . . . .	37
2.5 The planar algebra of a Hopf algebra . . . . .	38
2.6 Cabling . . . . .	41



<b>3</b>	<b>Infinite iterated crossed products and Drinfeld doubles</b>	<b>42</b>
3.1	Iterated crossed products . . . . .	43
3.2	The Drinfeld double construction . . . . .	48
3.3	Basic construction, crossed products and recognition . . . . .	50
3.4	The main theorem . . . . .	54
<b>4</b>	<b>Cabling and Drinfeld doubles</b>	<b>57</b>
4.1	The planar algebra morphism . . . . .	58
4.2	Injectivity . . . . .	64
4.3	Characterisation of the image . . . . .	67
4.4	The main theorem . . . . .	71
	<b>Bibliography</b>	<b>73</b>

## SYNOPSIS

This thesis deals with the mathematical objects known as planar algebras and their connection with Hopf algebras and their Drinfeld doubles. The motivation for this thesis comes from a series of talks delivered by Prof. Masaki Izumi at IMSc., Chennai, during one of which he asserted that for a Kac algebra subfactor, a related subfactor to its asymptotic inclusion comes from an outer action of its Drinfeld double. This is a folklore result in subfactor theory and in the process of trying to prove this, we noticed a purely algebraic result which also seemed quite interesting and this is one of the main results in the thesis. The result is roughly the following. Given a finite dimensional Hopf algebra  $H$  over any field, we associate to it a very natural inclusion  $A \subseteq B$  of infinite iterated crossed product algebras, namely,  $B = H^{op(-\infty, \infty)} = \dots \rtimes H^{op} \rtimes H^{op*} \rtimes H^{op} \rtimes \dots$  and  $A = H^{op(-\infty, -1]} \otimes H^{op[2, \infty)}$ . We then show that  $B$  is the crossed product of  $A$  by  $D(H)$  where  $D(H)$  denotes the Drinfeld double of  $H$ . More significantly, we show that  $D(H)$  is the only finite-dimensional Hopf algebra with this property and thus produce a context in which the Drinfeld double arises very naturally.

While proving this, we identify an explicit algebra embedding of  $D(H)$  into the iterated crossed product  $H^* \rtimes H \rtimes H^*$  which, in case  $H$  is semisimple and cosemisimple over an algebraically closed field, certainly may be regarded as a map from  $D(H) = P_{2,+}(D(H))$  to  $P_{4,+}(H^*) = {}^{(2)}P_{2,+}(H^*)$  where  $P(D(H))$  denotes the planar algebra of  $D(H)$ . It is thus a natural question to ask whether the embedding of  $D(H)$  into  $H^* \rtimes H \rtimes H^*$  may be extended to a planar algebra map in some canonical fashion, and it is the affirmative answer to this question that is the second main result of this thesis. We further show that this planar algebra map is injective and characterise the image of  $P(D(H))$  in  ${}^{(2)}P(H^*)$ .

The thesis is divided into four chapters. Chapters 1 and 2 are devoted to a discussion of preliminary notions, namely, Hopf algebras and planar algebras, while

the main content of the thesis is contained in Chapters 3 and 4. In a little more detail, the contents of the chapters are as follows.

**Chapter 1: Hopf algebras.** The goal of the first chapter is to summarise relevant facts about Hopf algebras - particularly those that are finite-dimensional and semisimple and cosemisimple. Beginning this chapter with a brief overview of Hopf algebras, we then introduce the important notion of integrals for finite-dimensional Hopf algebras and conclude the chapter with a discussion on semisimple Hopf algebras.

**Chapter 2: Planar algebras.** We begin this chapter with a discussion of planar tangles and two closely related notions of planar algebras. We then discuss the generators and relations approach to planar algebras in some detail. As an important example of this, we describe the planar algebra associated to a semisimple and cosemisimple Hopf algebra over an algebraically closed field. The chapter concludes with a discussion of cabled planar algebras.

**Chapter 3: Infinite iterated crossed products and Drinfeld doubles.** The first section in this chapter introduces the notions of action of a finite-dimensional Hopf algebra  $H$  on an algebra and that of infinite iterated crossed products. Using this, we define an inclusion of (infinite-dimensional) algebras called the derived pair of  $H$  which plays an important role in the main result of this chapter. The next, short section summarises the Drinfeld double construction. The third section is devoted to a study of an algebraic basic construction and its application in proving a recognition result for crossed products. The final section proves that the derived pair of  $H$  arises from a crossed product action by the Drinfeld double.

**Chapter 4: Cabling and Drinfeld doubles.** This chapter has, as its take-off point, a certain explicit algebra inclusion of  $D(H)$  into the iterated crossed product  $H^* \rtimes H \rtimes H^*$ , that was established in the course of proving the main result of Chapter 3. The first section of this chapter is devoted to proving that this map

extends to an injective planar algebra homomorphism from  $P(D(H))$  to  ${}^{(2)}P(H^*)$ . The next section shows that this planar algebra map is injective, thus identifying the planar algebra of the Drinfeld double as a planar subalgebra of  ${}^{(2)}P(H^*)$ . The remaining two sections characterise the image of  $P(D(H))$  in  ${}^{(2)}P(H^*)$ .

# List of Figures

1.1	Associativity . . . . .	16
1.2	Unit . . . . .	17
1.3	Coassociativity . . . . .	17
1.4	Counit . . . . .	17
2.1	Some important tangles ( $m, n, j \geq 0$ ) . . . . .	33
2.2	Renumbering compatibility . . . . .	33
2.3	Compatibility condition when $\tilde{b} > 0$ . . . . .	34
2.4	Compatibility condition when $\tilde{b} = 0$ . . . . .	34
2.5	Planar algebra morphism . . . . .	35
2.6	The L(inearity) and M(odulus) relations . . . . .	39
2.7	The U(nit) and I(ntegral) relations . . . . .	39
2.8	The C(ounit) and T(race) relations . . . . .	39
2.9	The E(xchange) and A(ntipode) relations . . . . .	39
2.10	Algebra isomorphisms . . . . .	41
3.1	Multiplication in $H^{[i,j]}$ for $i, j$ even . . . . .	45

4.1	Mapping $\tilde{D}(H)$ to $P_{4,+}(H^*)$ . . . . .	59
4.2	Equality to be verified in $P_{4,+}(H^*)$ . . . . .	60
4.3	Computation in $P(H^*)$ . . . . .	60
4.4	Relation C . . . . .	61
4.5	Relation T . . . . .	61
4.6	Multiplication and comultiplication relations . . . . .	62
4.7	Equality to be verified for the multiplication relation . . . . .	62
4.8	Equality to be verified for the comultiplication relation . . . . .	63
4.9	Equivalent equality to be verified . . . . .	63
4.10	Inductive definition of $X^{k+1,+}$ . . . . .	65
4.11	$\Psi_{k,\epsilon} \circ Z_{X^{k,+}}^P((f^1 \otimes x^1) \otimes (f^2 \otimes x^2) \otimes \dots \otimes (f^{(k-1)} \otimes x^{(k-1)}))$ . . . . .	65
4.12	The tangle $S^{2k,+}$ . . . . .	65
4.13	Definition of $\alpha_x(X)$ and $\beta_x(X)$ . . . . .	67
4.14	Definition of $\theta_k(x)$ . . . . .	68
4.15	Definition of $\tilde{X}$ . . . . .	68
4.16	$\tilde{X}$ when $X \in P(H^*)_{4k,+}$ and $\alpha_h(X) = X$ . . . . .	68
4.17	Equivalent form of $\tilde{X}$ when $X \in P(H^*)_{4k,+}$ and $\alpha_h(X) = X$ . . . . .	69
4.18	Equivalent form of the first commutativity relation . . . . .	69
4.19	Equivalent form of the second commutativity relation . . . . .	70
4.20	Form of $X \in Q_{2k,+}$ . . . . .	70
4.21	The tangle $V^{2k,+}$ . . . . .	71

4.22 Characterisation of the image . . . . .	72
--	----

# Chapter 1

## Hopf algebras

### 1.1 Hopf algebras

The goal of this chapter is to introduce the mathematical objects called Hopf algebras. For details we refer to [23], [13] and [19] and also to [1]. All the vector spaces considered in this chapter will be over an arbitrary field  $k$ . We begin this chapter with a brief overview of Hopf algebras. We then introduce the important notion of integrals for finite-dimensional Hopf algebras and finally conclude the chapter with a discussion on semisimple Hopf algebras and also recall several useful facts which we will be using frequently in later chapters.

**Definition 1.1.1.** *An algebra over a field  $k$  is a triple  $(A, \mu, \eta)$  where  $A$  is a vector space and  $\mu : A \otimes A \rightarrow A$  and  $\eta : k \rightarrow A$  are linear maps such that the following diagrams commute.*

$$\begin{array}{ccc} A \otimes A \otimes A & \xrightarrow{\mu \otimes Id} & A \otimes A \\ Id \otimes \mu \downarrow & & \downarrow \mu \\ A \otimes A & \xrightarrow{\mu} & A \end{array}$$

Figure 1.1: Associativity



$$\begin{array}{ccccc}
k \otimes A & \xrightarrow{\eta \otimes Id} & A \otimes A & \xleftarrow{Id \otimes \eta} & A \otimes k \\
& \searrow \cong & \downarrow \mu & \swarrow \cong & \\
& & A & & 
\end{array}$$

Figure 1.2: Unit

Note that  $\eta(1_k)$  serves as the unit of  $A$  where  $1_k$  denotes the multiplicative identity of  $k$ .

**Remark 1.1.2.** For any algebra  $(A, \mu, \eta)$ , set  $\mu^{op} = \mu \circ \tau_{A,A}$  where  $\tau_{A,A} : A \otimes A \rightarrow A \otimes A$  is the flip map i.e.  $\tau(a \otimes a') = a' \otimes a$  for all  $a \otimes a'$  in  $A \otimes A$ . Then  $(A, \mu^{op}, \eta)$  is an algebra which we call the opposite algebra.

**Definition 1.1.3.** A coalgebra is a triple  $(C, \Delta, \epsilon)$  consisting of a vector space  $C$  together with two linear maps  $\Delta : C \rightarrow C \otimes C$  (called comultiplication) and  $\epsilon : C \rightarrow k$  (called counit) such that the following diagrams commute.

$$\begin{array}{ccc}
C & \xrightarrow{\Delta} & C \otimes C \\
\Delta \downarrow & & \downarrow \Delta \otimes Id \\
C \otimes C & \xrightarrow{Id \otimes \Delta} & C \otimes C \otimes C
\end{array}$$

Figure 1.3: Coassociativity

$$\begin{array}{ccccc}
k \otimes C & \xleftarrow{\epsilon \otimes Id} & C \otimes C & \xrightarrow{Id \otimes \epsilon} & C \otimes k \\
& \swarrow \cong & \uparrow \Delta & \searrow \cong & \\
& & C & & 
\end{array}$$

Figure 1.4: Counit

**Remark 1.1.4.** Given a coalgebra  $(C, \Delta, \epsilon)$ , if we set  $\Delta^{op} = \tau_{C,C} \circ \Delta$ , then  $(C, \Delta^{op}, \epsilon)$  becomes a coalgebra which we call the opposite coalgebra.

**Example 1.1.5.** The following are some examples of coalgebras.

(1) *(Coalgebra of a set)* Let  $X$  be a set and  $C = kX = \bigoplus_{x \in X} kx$  be the  $k$ -vector space with basis  $X$ . Then  $C$  can be endowed with a coalgebra structure by defining

$$\Delta(x) = x \otimes x \text{ and } \epsilon(x) = 1$$

for all  $x$  in  $X$ .

(2) *The dual vector space of a finite-dimensional algebra has a coalgebra structure.* It relies on the basic fact that if  $V$  and  $W$  are two  $k$ -vector spaces and if one of  $W$  or  $V$  is finite-dimensional, then  $V^* \otimes W^*$  is naturally isomorphic to  $(V \otimes W)^*$  by the isomorphism  $T_{V,W} : V^* \otimes W^* \rightarrow (V \otimes W)^*$  given by  $T_{V,W}(f \otimes g)(v \otimes w) = f(v)g(w)$ . Thus if  $(A, \mu, \eta)$  is a finite-dimensional algebra, and we define  $\Delta := T_{A,A}^{-1} \circ \mu^* : A^* \rightarrow A^* \otimes A^*$  and  $\epsilon := \eta^* : A^* \rightarrow k$ , one can easily check that  $(A^*, \Delta, \epsilon)$  is a coalgebra.

(3) *(The matrix coalgebra)* Let  $A = M_n(k)$  be the algebra of  $n$  by  $n$  matrices over  $k$ . Then  $\{E_{ij} : 1 \leq i, j \leq n\}$ , where  $E_{ij}$  denotes the matrix whose  $(i, j)$ th entry is 1 and all other entries are zero, is a basis of  $A$ . Let  $\{x_{ij}\}$  denote the dual basis. Then by virtue of Example 1.1.5(2) above,  $A^*$  becomes a coalgebra and one can easily check that

$$\Delta(x_{ij}) = \sum_{k=1}^n x_{ik} \otimes x_{kj} \text{ and } \epsilon(x_{ij}) = \delta_{ij}.$$

(4) *(The tensor product of two coalgebras)* The tensor product of two coalgebras  $(C, \Delta, \epsilon)$  and  $(C', \Delta', \epsilon')$  has a coalgebra structure with the comultiplication  $(Id_C \otimes \tau_{C,C'} \otimes Id_{C'}) \circ (\Delta \otimes \Delta')$  and counit  $\epsilon \otimes \epsilon'$ .

We next define morphism of coalgebras.

**Definition 1.1.6.** Consider two coalgebras  $(C, \Delta, \epsilon)$  and  $(C', \Delta', \epsilon')$ . A linear map

$f$  from  $C$  to  $C'$  is a morphism of coalgebras if  $(f \otimes f) \circ \Delta = \Delta' \circ f$  and  $\epsilon = \epsilon' \circ f$ .

We now present Sweedler's notation which we shall use continually in the sequel. Let  $(C, \Delta, \epsilon)$  be a coalgebra. Let  $\Delta^n : C \rightarrow C^{\otimes n}$  be defined inductively for  $n \geq 2$  by  $\Delta^2 = \Delta$  and

$$\Delta^n = (\Delta \otimes Id_{C^{\otimes(n-1)}}) \circ \Delta^{n-1} = (Id_{C^{\otimes(n-1)}} \otimes \Delta) \circ \Delta^{n-1}, n \geq 3.$$

If  $x$  is an element of  $C$ , we shall further abbreviate the usual Sweedler notation  $\Delta^n(x) = \sum_{i \in I} x_1^i \otimes x_2^i \otimes \dots \otimes x_n^i$  (the sum over a finite index set  $I$ ) by omitting explicit mention of both the summation symbol and the index, and write  $\Delta^n(x) = x_1 \otimes x_2 \otimes \dots \otimes x_n$ .

We now describe a special class of elements of a coalgebra.

**Definition 1.1.7.** *An element  $g$  of a coalgebra  $C$  is called a grouplike element if  $g \neq 0$  and  $\Delta(g) = g \otimes g$ . The set of grouplike elements of a coalgebra  $C$  is denoted by  $G(C)$ .*

The counit property implies that  $\epsilon(g) = 1$  for any  $g \in G(C)$ . Moreover, grouplike elements are linearly independent. The following proposition shows that grouplike elements of the dual coalgebra of a finite-dimensional algebra have a special feature. For any algebra  $A$  over  $k$ , let  $Alg(A, k)$  be the set of all algebra homomorphisms from  $A$  to  $k$ .

**Proposition 1.1.8.** *Let  $A$  be a finite-dimensional algebra and let  $A^*$  be the dual coalgebra. Then,  $G(A^*) = Alg(A, k)$ .*

*Proof.* Let  $f \in G(A^*)$ . Then  $\Delta(f) = f \otimes f$  implies that  $f(ab) = f(a)f(b)$  for all  $a, b$  in  $A$ . Also,  $f(1) = \epsilon(f) = 1$ . Thus,  $f \in Alg(A, k)$ . The reverse inclusion is similar. □

We next pass to a bialgebra, namely a vector space which is simultaneously an algebra and a coalgebra with these two structures being compatible in the following sense. Let  $H$  be a vector space equipped simultaneously with an algebra structure  $(H, \mu, \eta)$  and a coalgebra structure  $(H, \Delta, \epsilon)$ .

**Theorem 1.1.9.** *The following two statements are equivalent:*

(1)  $\mu$  and  $\eta$  are morphisms of coalgebras.

(2)  $\Delta$  and  $\epsilon$  are morphisms of algebras. □

This leads to the following definition.

**Definition 1.1.10.** *A bialgebra is a quintuple  $(H, \mu, \eta, \Delta, \epsilon)$  where  $(H, \mu, \eta)$  is an algebra and  $(H, \Delta, \epsilon)$  is a coalgebra satisfying the equivalent conditions of Theorem 1.1.9. A morphism of bialgebras is a morphism for the underlying algebra and coalgebra structures.*

Suppose  $(H, \mu, \eta, \Delta, \epsilon)$  is a bialgebra. Using Sweedler's notational convention we see that the condition  $\Delta(xy) = \Delta(x)\Delta(y)$  is expressed by

$$(xy)_1 \otimes (xy)_2 = x_1 y_1 \otimes x_2 y_2, \text{ for all } x, y \text{ in } H.$$

We also have

$$\Delta(1) = 1 \otimes 1, \epsilon(xy) = \epsilon(x)\epsilon(y) \text{ and } \epsilon(1) = 1.$$

We now proceed to define Hopf algebras. Given an algebra  $(A, \mu, \eta)$  and a coalgebra  $(C, \Delta, \epsilon)$  we define a bilinear map, called convolution, on the vector space  $\text{Hom}(C, A)$  of all linear maps from  $C$  to  $A$ . Given  $f, g$  in  $\text{Hom}(C, A)$ , then the convolution of  $f$  and  $g$ , denoted by  $f \star g$ , is defined to be the composition of the

maps

$$C \xrightarrow{\Delta} C \otimes C \xrightarrow{f \otimes g} A \otimes A \xrightarrow{\mu} A.$$

Using Sweedler's notation, we have

$$(f \star g)(x) = f(x_1)g(x_2), \text{ for any element } x \text{ in } H.$$

**Proposition 1.1.11.** *The triple  $(\text{Hom}(C, A), \star, \eta \circ \epsilon)$  is an algebra. □*

Let  $(H, \mu, \eta, \Delta, \epsilon)$  be a bialgebra. Then with  $C = A = H$ , we define the convolution in the vector space  $\text{End}(H)$  of endomorphisms of  $H$ .

**Definition 1.1.12.** *Let  $(H, \mu, \eta, \Delta, \epsilon)$  be a bialgebra. An element  $S$  in  $\text{End}(H)$  is called an antipode for the bialgebra  $H$  if*

$$S \star \text{Id}_H = \text{Id}_H \star S = \eta \circ \epsilon.$$

*A Hopf algebra is a bialgebra with an antipode. A morphism of Hopf algebras is a morphism of the underlying bialgebras commuting with the antipodes.*

A bialgebra does not necessarily have an antipode. But if it has, then it is unique. Indeed, if  $S$  and  $S'$  are antipodes, then

$$S = S \star (\eta \circ \epsilon) = S \star (\text{Id}_H \star S') = (S \star \text{Id}_H) \star S' = (\eta \circ \epsilon) \star S' = S'.$$

A Hopf algebra with an antipode  $S$  will be denoted by  $(H, \mu, \eta, \Delta, \epsilon, S)$ . Using Sweedler's notation, we see that an antipode satisfies the relations

$$Sx_1x_2 = x_1Sx_2 = \epsilon(x)1, \text{ for all } x \text{ in } H.$$

**Proposition 1.1.13.** *The antipode for a finite-dimensional Hopf algebra is bijective.*

*Proof.* For the proof we refer to [1, Corollary 5.2.6]. □

The next two propositions give ways of obtaining new Hopf algebras from old.

**Proposition 1.1.14.** *Let  $H$  be a Hopf algebra with antipode  $S$ , then  $H^*$  is a Hopf algebra with antipode  $S^*$ .* □

**Proposition 1.1.15.** *Let  $(H, \mu, \eta, \Delta, \epsilon, S)$  be a Hopf algebra. Then*

$$H^{op} = (H, \mu^{op}, \eta, \Delta, \epsilon, S^{-1}), H^{cop} = (H, \mu, \eta, \Delta^{op}, \epsilon, S^{-1}), H^{op,cop} = (H, \mu^{op}, \eta, \Delta^{op}, \epsilon, S)$$

*are Hopf algebras.* □

**Example 1.1.16.** *The following are examples of Hopf algebras.*

(1) *If  $G$  is a finite group, then already we have mentioned in Example 1.1.5(1) that the group algebra  $kG$  has also a coalgebra structure and one can check that  $kG$  thus becomes a bialgebra. Further, the map  $S : kG \rightarrow kG$  defined by  $S(g) = g^{-1}$  for all  $g$  in  $G$  and then extended linearly, is the antipode of the bialgebra  $kG$ . Thus,  $kG$  is a Hopf algebra.*

*It follows from the Proposition 1.1.14 that  $(kG)^*$  also has a Hopf algebra structure.*

(2) *(Sweedler's 4- dimensional Hopf algebra) Assume that  $\text{char}(k) \neq 2$ . Let  $H$  be the algebra given by the generators and relations as follows: As a  $k$ -algebra,  $H$  is generated by  $c$  and  $x$  satisfying the relations*

$$c^2 = 1, x^2 = 0, xc = -cx.$$

*Then  $H$  has dimension 4 as a  $k$ -vector space with basis  $\{1, c, x, cx\}$ . The coalgebra structure is given by*

$$\Delta(c) = c \otimes c, \Delta(x) = c \otimes x + x \otimes 1, \epsilon(c) = 1, \epsilon(x) = 0.$$

One sees that  $H$  thus becomes a bialgebra which also possesses an antipode  $S$  defined by  $S(c) = c^{-1}, S(x) = -cx$ . This was the first example of a non-commutative and non-cocommutative Hopf algebra.

## 1.2 Integrals

We introduce the notion of integrals for a finite-dimensional Hopf algebra. Let  $H(\mu, \eta, \Delta, \epsilon, S)$  be a finite-dimensional Hopf algebra over any field  $k$ .

**Definition 1.2.1.** *An element  $h$  in  $H$  is said to be a left- (resp., right-) integral if  $xh = \epsilon(x)h$  (resp.,  $hx = \epsilon(x)h$ ) for all  $x$  in  $H$ .*

*Similarly, an element  $p$  in  $H^*$  is said to be a left- (resp., right-) integral if  $fp = f(1)p$  (resp.,  $pf = f(1)p$ ) for all  $f$  in  $H^*$ .*

**Example 1.2.2.** (1) *Let  $G$  be a finite group and consider the Hopf algebra  $kG$ .*

*Then one can easily check that  $h = \sum_{g \in G} g$  is a left- (and right-) integral for  $kG$ .*

(2) *If  $G$  is a finite group, consider the Hopf algebra  $(kG)^*$ , the dual of  $kG$ . It is easy to see that the element  $p \in (kG)^*$  defined by  $p(g) = \delta_{1,g}$ , is a left- (and right-) integral for  $(kG)^*$ .*

(3) *If  $H$  denotes Sweedler's 4-dimensional Hopf algebra as described in Example 1.1.16(2), then  $x + cx$  is a left-integral in  $H$  and  $x - cx$  is a right-integral in  $H$ .*

**Remark 1.2.3.** *If  $h$  is a left-integral for  $H$ , then  $Sh$  is a right-integral for  $H$ .*

The following theorem ensures existence of nonzero integrals in a finite-dimensional Hopf algebra.

**Theorem 1.2.4.** (1) *In any finite-dimensional Hopf algebra the space of left- (resp., right-) integrals is one dimensional.*

(2) *Further, if  $h$  denotes a nonzero left- or right-integral for  $H$  and  $p$  denotes a nonzero right- or left-integral for  $H^*$ , then  $p(h) \neq 0$ .*

*Proof.* The proof of (1) can be found in [1, Corollary 5.2.6] and also in [23, Corollary 5.1.6], while for the proof of (2) the reader may look at [22, Corollary 1]. We also refer to the beautiful pictorial treatment in [14, Theorem 1] which uses Kuperberg's diagrammatic formalism for Hopf objects which was first defined and developed in [18]. □

It may happen that the spaces of left- and right-integrals for a finite-dimensional Hopf algebra are the same. We have a name for such Hopf algebras.

**Definition 1.2.5.** *A finite-dimensional Hopf algebra is said to be unimodular if the spaces of left- and right-integrals are the same.*

We now state several important facts concerning integrals and prove a few of them which we will use frequently in the sequel.

**Lemma 1.2.6.** *Let  $H$  be a finite-dimensional Hopf algebra over any field  $k$  with antipode  $S$ .*

- (1) *If  $h \in H$  is a right-integral, then  $h_1a \otimes h_2 = h_1 \otimes h_2Sa$  for all  $a$  in  $H$ .*
- (2) *If  $h \in H$  is a left-integral, then  $ah_1 \otimes h_2 = h_1 \otimes S^{-1}ah_2$  for all  $a$  in  $H$ .*
- (3) *If  $h \in H$  and  $p \in H^*$  are right-integrals, then  $p(h_1a)h_2 = p(h)Sa$  for all  $a$  in  $H$ .*
- (4) *If  $h \in H$  is a left-integral and  $p \in H^*$  is a right integral, then  $p(ah_1)h_2 = p(h)S^{-1}a$  for all  $a$  in  $H$ .*



*Proof.* To prove (1) we note that

$$h_1 a \otimes h_2 = h_1 a_1 \otimes h_2 a_2 S a_3 = \Delta(h a_1)(1 \otimes S a_2) = \Delta(h)(1 \otimes S a) = h_1 \otimes h_2 S a.$$

The proofs of (2), (3) and (4) are similar.  $\square$

**Corollary 1.2.7.** *Let  $H$  be a finite-dimensional unimodular Hopf algebra over a field  $k$  with antipode  $S$ . Let  $h \in H$  be a nonzero integral. Then  $S(h) = h$ .*

*Proof.* Let  $p \in H^*$  be a nonzero right-integral. Suppose  $h$  is a nonzero integral in  $H$ . Then the desired result follows from Lemma 1.2.6(3) with  $a = h$ .  $\square$

**Remark 1.2.8.** *A similar statement holds if  $H^*$  is unimodular and in this case we have that  $S^* p = p \circ S = p$  where  $p$  is a nonzero integral in  $H^*$ .*

If  $H$  is a finite-dimensional Hopf algebra over  $k$ , then consider the elements  $p, p'$  in  $H^*$  defined by

$$p(a) = \text{tr}_H(\lambda_a S^2), \text{ for all } a \in H$$

and

$$p'(a) = \text{tr}_H(\lambda_a S^{-2}), \text{ for all } a \in H$$

where  $\lambda_a \in \text{End}_k(H)$  denotes left multiplication by  $a$ .

**Proposition 1.2.9.** *With the above notation,  $p$  is a left-integral and  $p'$  is a right-integral of  $H^*$ .*

*Proof.* For the proof we refer to [21, Proposition 4].  $\square$

We now need to recall Fourier transform maps.

**Definition 1.2.10.** Suppose  $H$  is a finite-dimensional Hopf algebra over any field  $k$ . If  $p$  denotes a nonzero integral (right- or left-) of  $H^*$ , consider the linear maps  $F_p, F^p : H \longrightarrow H^*$  defined by  $F_p(a) = p_1(a)p_2$  and  $F^p(a) = p_2(a)p_1$  where  $a$  is in  $H$ . Such maps are called the Fourier transform maps of  $H$ . Similarly we may define the Fourier transform maps for  $H^*$ .

**Remark 1.2.11.** If  $H$  is a finite-dimensional Hopf algebra, we assert that the Fourier transform maps of  $H$  are bijective. It follows from the observations that if  $p$  is a nonzero integral in  $H^*$ , say right-integral, then  $F_h F_p = p(h)S^{-1}$ ,  $F^p F^h = p(h)S^{-1}$  where  $h$  is a nonzero left-integral in  $H$  and also  $F_p F^{h'} = p(h')S$ ,  $F_{h'} F^p = p(h')S$  if  $h'$  is a nonzero right-integral of  $H$  and thus proving bijectivity of  $F_p$  as well as  $F^p$ . Similarly, we can show bijectivity of  $F_p, F^p$  in case  $p$  is a nonzero left-integral of  $H^*$ .

### 1.3 Semisimple Hopf algebras

The purpose of this section is to briefly review semisimple Hopf algebras. We start with the mention of an important result, known as Maschke's theorem, which is an important application of integrals in finite-dimensional Hopf algebras.

**Theorem 1.3.1.** Let  $H$  be a finite-dimensional Hopf algebra. Then  $H$  is a semisimple algebra if and only if  $\epsilon(h) \neq 0$  for a left-integral  $h \in H$ .

*Proof.* The proof can be found in [23, Theorem 5.1.8]. □

**Remark 1.3.2.** Consider the Hopf algebra  $H = kG$  of Example 1.1.16(1). We have already seen that  $h = \sum_{g \in G} g$  is a left-integral for  $H$ . Then  $\epsilon(h) = |G|1_k$  where  $|G|$  denotes the order of the group. The preceding theorem tells that the Hopf algebra  $kG$  is semisimple if and only if  $|G|1_k \neq 0$  in  $k$ , hence if and only if the characteristic of the field  $k$  does not divide  $|G|$ . This is the well-known Maschke's theorem for

groups. For Sweedler's Hopf algebra of Example 1.1.16(2), Theorem 1.3.1 shows that it is not semisimple.

We next show that a finite-dimensional semisimple Hopf algebra is unimodular. For this we need to introduce the notion of the distinguished grouplike element. Given a nonzero left-integral  $h$  in a finite-dimensional Hopf algebra  $H$ , note that for any  $x \in H$ ,  $hx$  is a left-integral so that  $hx = \alpha(x)h$  for  $\alpha(x) \in k$ . Also note that  $\alpha \in \text{Alg}(H, k)$  and hence  $\alpha \in G(H^*)$  (see Proposition 1.1.8). Now for any nonzero right-integral  $h'$ , we observe that for any  $x$  in  $H$ ,  $xh' = \alpha^{-1}(x)h'$ .

**Definition 1.3.3.** *The element  $\alpha$  constructed above is called the distinguished grouplike element of  $H$  (For details, see [20]).*

**Remark 1.3.4.** *Clearly,  $H$  is unimodular if and only if  $\alpha = \epsilon$ .*

**Lemma 1.3.5.** *If  $H$  is semisimple, then it is unimodular.*

*Proof.* Choose a left-integral  $h$  in  $H$  with  $\epsilon(h) \neq 0$ . Then, for any  $x \in H$ ,  $\alpha(x)\epsilon(h)h = \alpha(x)h^2 = (hx)h = h(xh) = \epsilon(x)h^2 = \epsilon(x)\epsilon(h)h$ . Since  $\epsilon(h) \neq 0$ , we see that  $\alpha(x) = \epsilon(x)$ , for all  $x$  in  $H$ . Thus,  $\alpha = \epsilon$  and so  $H$  is unimodular by the preceding remark.  $\square$

**Proposition 1.3.6.** *Let  $H$  be a semisimple Hopf algebra. Let  $p$  and  $p'$  have the same meaning as in Proposition 1.2.9.*

(1) *Then  $p$  is a nonzero left-integral and  $p'$  is a nonzero right-integral of  $H^*$ .*

(2)  *$H^*$  is semisimple if and only if  $\text{tr}_H(S^2) \neq 0$ .*

*Proof.* (1) Let  $h$  denote the unique nonzero idempotent integral for  $H$ . Then  $p(h) = p'(h) = 1$ . Hence the result.

(2) If  $H^*$  is semisimple, denote by  $\psi$  the unique idempotent nonzero integral in  $H^*$ . Note  $\psi = cp$  for some nonzero scalar  $c$ . Then  $\psi = \psi^2 = c^2p^2 = c^2p(1)p = c^2\text{tr}_H(S^2)p$ . Thus  $\text{tr}_H(S^2) \neq 0$ . Converse is obvious.  $\square$

**Proposition 1.3.7.** *Let  $H$  be a unimodular finite-dimensional Hopf algebra over a field  $k$  with antipode  $S$  such that  $H^*$  is also unimodular. Let  $h \in H$  be a nonzero integral. Then,  $h_1 \otimes h_2 = S^2 h_2 \otimes h_1$ .*

*Proof.* Let  $p \in H^*$  be a nonzero integral. Then Theorem 1.2.4(2) tells that  $p(h)$  is nonzero. Denote this value by  $\beta$ . We also know that  $S(h) = h$  and  $S^*(p) = p$  by Corollary 1.2.7 and Remark 1.2.8. Take arbitrary  $x$  in  $H$  and let  $f = p_1(x)p_2$ . Then, repeated application of Lemma 1.2.6 and Remark 1.2.8 show that

$$f(h_2)h_1 = p_1(x)p_2(h_2)h_1 = p(xh_2)h_1 = p(h_2)Sxh_1 = \beta Sx$$

and also,

$$\beta Sx = p(h_1)Sxh_2 = p(S^2 h_1)SxS^2 h_2 = p(h_1)S^2(S^{-1}xh_2) = p(xh_1)S^2 h_2 = f(h_1)S^2 h_2.$$

Thus we conclude that  $f(h_2)h_1 = f(h_1)S^2 h_2$  and this holds for arbitrary  $f$  in  $H^*$  since by the Remark 1.2.11 the Fourier transform map  $F_p$  is bijective. Therefore,  $h_1 \otimes h_2 = S^2 h_2 \otimes h_1$ .  $\square$

In the paper [4], authors proved Kaplansky's 5th conjecture which is as follows.

**Theorem 1.3.8.** *The square of the antipode of any finite-dimensional semisimple and cosemisimple Hopf algebra over any field is the identity.*

*Proof.* See [4, Theorem 3.1] for the proof.  $\square$

And as a corollary to this the authors proved in [4] (see [4, Corollary 3.2]) various facts about finite-dimensional semisimple and cosemisimple Hopf algebras over any field which we state below.

**Corollary 1.3.9.** *Let  $H$  be a finite-dimensional Hopf algebra with antipode  $S$  over any field  $k$ . Then:*

(1)  $H$  is semisimple and cosemisimple if and only if  $S^2 = I$  and  $\dim_k H \neq 0$  in  $k$ .

(2) If  $H$  is semisimple and cosemisimple and  $k$  is algebraically closed, then for any irreducible representation  $V$  of  $H$ ,  $\dim_k V \neq 0$  in  $k$ .  $\square$

**Corollary 1.3.10.** *Let  $H$  be a finite-dimensional semisimple and cosemisimple Hopf algebra over any field. Let  $h$  be a nonzero integral in  $H$ . Then  $h_1 \otimes h_2 = h_2 \otimes h_1$ .*

*Proof.* Follows immediately from the Proposition 1.3.7 and the Theorem 1.3.8.  $\square$

**Proposition 1.3.11.** *Let  $H$  be a finite-dimensional semisimple and cosemisimple Hopf algebra over a field  $k$ . Let  $p$  (resp.,  $h$ ) denote the unique nonzero idempotent integral in  $H^*$  (resp.,  $H$ ). Then  $p(h) = \frac{1}{\dim_k H}$ .*

*Proof.* Follows easily from the Theorem 1.3.8, Proposition 1.2.9 and Corollary 1.3.9.  $\square$

# Chapter 2

## Planar algebras

The notion of planar algebras has been evolving since Jones introduced it in [8]. This chapter is devoted to a survey of some facts about planar algebras which we will need in the sequel. We first recall the definition of planar tangles and then present a brief overview of planar algebras and discuss some properties of it and finally discuss the planar algebra associated to a semisimple and cosemisimple Hopf algebra over an algebraically closed field and conclude the chapter with a brief discussion on the notion of cabling of planar algebras.

### 2.1 Planar tangles and operations on tangles

Consider the set  $Col = \{0, 1, 2, \dots\} \times \{\pm 1\}$ , elements of which we refer to as colours. We will typically write a colour as  $(k, \epsilon)$  where  $\epsilon$  is either  $+$  or  $-$  and stands for  $+1$  or  $-1$ .

A tangle is a subset of the plane that is the complement of the union of the interiors of a (possibly empty) collection of labelled internal discs in an external disc, along with the following data.

- (1) Each disc has an even number (again, possibly 0) of points marked on its boundary circles.
- (2) There is also given a collection of disjoint curves on the tangle each of which is either a simple closed curve, or joins a marked point on one of the circles to another such. Each marked point on a disc must be the end-point of one of the curves. For each disc, one of its boundary arcs (= connected components of the complement of the marked points on the boundary circle) is distinguished and marked with a  $*$  placed near it. Further, strings are allowed to intersect boundaries only transversally, not tangentially.
- (3) Finally, there is given a checkerboard shading of the regions (= connected components of the complement of the curves) such that across any curve, the shading toggles.

A disc with  $2n$  marked points on its boundary is said to be an  $(n, +)$  disc or an  $(n, -)$  disc according as its  $*$ -arc is adjacent to a white or a black region. The colour of a tangle is the colour of its external disc. Tangles are defined only up to a planar isotopy preserving the  $*$ -arcs, the shading and the numbering of the internal discs. As is usual, we will often refer to and draw the discs as boxes with their  $*$ -arcs being their leftmost arc and sometimes omit drawing the external disc/box. We use the notation  $T_{(k_1, \epsilon_1), (k_2, \epsilon_2), \dots, (k_b, \epsilon_b)}^{(k_0, \epsilon_0)}$  to denote a tangle  $T$  of colour  $(k_0, \epsilon_0)$  with  $b$  internal discs ( $b$  may be zero also) such that  $i$ -th internal disc of  $T$  has colour  $(k_i, \epsilon_i)$ . We often omit the parantheses and denote an  $(n, \epsilon)$ -tangle  $T$  by  $T^{n, \epsilon}$  without any reference to internal discs and also use the notation  $T_{k_2, \epsilon_2}^{k_1, \epsilon_1}$ , instead of  $T_{(k_2, \epsilon_2)}^{(k_1, \epsilon_1)}$ , to denote a tangle  $T$  of colour  $(k_1, \epsilon_1)$  with a single internal disc of colour  $(k_2, \epsilon_2)$ . We also write  $D_i(T)$  to denote the  $i$ -th internal disc of  $T$ .

Two basic operations can be performed on tangles to produce new tangles from the old ones.

**Renumbering:** Let  $T = T_{(k_1, \epsilon_1), (k_2, \epsilon_2), \dots, (k_b, \epsilon_b)}^{(k_0, \epsilon_0)}$  be a tangle. Let  $\sigma$  be a permutation on the set  $\{1, 2, \dots, b\}$ . We define  $\sigma(T)$  to be the tangle that is identical to  $T$  as a subset of the plane, except for a numbering of the internal discs. The  $i$ -th internal disc of  $T$  is the  $\sigma(i)$ -th internal disc of  $\sigma(T)$ , i.e.,  $D_i(\sigma(T)) = D_{\sigma^{-1}(i)}(T)$ .

**Substitution:** Let  $T = T_{(k_1, \epsilon_1), (k_2, \epsilon_2), \dots, (k_b, \epsilon_b)}^{(k_0, \epsilon_0)}$  and  $S = S_{(\tilde{k}_1, \tilde{\epsilon}_1), (\tilde{k}_2, \tilde{\epsilon}_2), \dots, (\tilde{k}_{\tilde{b}}, \tilde{\epsilon}_{\tilde{b}})}^{(\tilde{k}_0, \tilde{\epsilon}_0)}$  be tangles such that the colour of the  $i$ -th internal disc of  $T$  is same as the colour of the external disc of  $S$  i.e.,  $(\tilde{k}_0, \tilde{\epsilon}_0) = (k_i, \epsilon_i)$ . Then we obtain the composite tangle  $T \circ_i S$  by substituting the tangle  $S$  into the  $i$ -th internal disc of  $T$  appropriately such that the  $*$ -arc of the external disc of  $S$  matches the  $*$ -arc of the  $i$ -th internal disc of  $T$  and then deleting the boundary circle. Thus  $T \circ_i S$  is a  $(k_0, \epsilon_0)$ -tangle with  $b + \tilde{b} - 1$  internal discs. The numbering of the internal discs will be as follows:

If  $\tilde{b} > 0$ , for each  $1 \leq j \leq b + \tilde{b} - 1$ , the  $j$ -th disc of  $T \circ_i S$  is the

$$\begin{cases} j\text{-th disc of } T, & \text{if } 1 \leq j \leq i - 1 \\ j - i + 1\text{-th disc of } S, & \text{if } i \leq j \leq i - 1 + \tilde{b} \\ j - \tilde{b} + 1\text{-th disc of } T, & \text{if } i - 1 + \tilde{b} < j \leq b + \tilde{b} - 1. \end{cases}$$

If  $\tilde{b} = 0$ , then  $T \circ_i S$  has  $b - 1$  internal discs and  $j$ -th internal disc of  $T \circ_i S$  is the

$$\begin{cases} j\text{-th disc of } T, & \text{if } 1 \leq j \leq i - 1 \\ j + 1\text{-th disc of } T, & \text{if } i \leq j \leq b - 1. \end{cases}$$

## 2.2 Some examples of tangles

We illustrate several important tangles in Figure 2.1. We use the following notational device for convenience in drawing tangles. A strand in a tangle with a non-negative integer, say  $t$ , adjacent to it will indicate a  $t$ -cable of that strand, i.e., a parallel cable of  $t$  strands, in place of the one actually drawn.



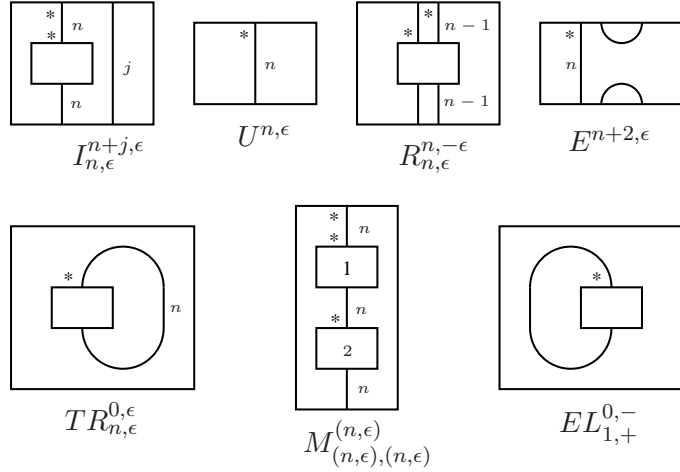

Figure 2.1: Some important tangles ( $m, n, j \geq 0$ )

## 2.3 Planar algebras

A planar algebra is a collection  $\{P_{(k,\epsilon)} : (k,\epsilon) \in Col\}$  of vector spaces over a field  $k$  such that given any tangle  $T = T_{(k_1,\epsilon_1),(k_2,\epsilon_2),\dots,(k_b,\epsilon_b)}^{(k_0,\epsilon_0)}$ , there is an associated linear map  $Z_T$

$$\begin{cases} P_{(k_1,\epsilon_1)} \otimes P_{(k_2,\epsilon_2)} \otimes \cdots \otimes P_{(k_b,\epsilon_b)} & \longrightarrow P_{(k_0,\epsilon_0)} \text{ if } b > 0, \\ k & \longrightarrow P_{(k_0,\epsilon_0)} \text{ if } b = 0. \end{cases}$$

There are three axioms to be satisfied for this association.

**Compatibility with Renumbering:** Given a tangle  $T = T_{(k_1,\epsilon_1),(k_2,\epsilon_2),\dots,(k_b,\epsilon_b)}^{(k_0,\epsilon_0)}$  with  $b > 0$  and a permutation  $\sigma$  on the set  $\{1, 2, \dots, b\}$ . Consider the tangle  $\sigma(T)$ . Then the following diagram must commute:

$$\begin{array}{ccc} P_{(k_1,\epsilon_1)} \otimes P_{(k_2,\epsilon_2)} \otimes \cdots \otimes P_{(k_b,\epsilon_b)} & \xrightarrow{U_\sigma} & P_{(k_{\sigma^{-1}(1)},\epsilon_{\sigma^{-1}(1)})} \otimes \cdots \otimes P_{(k_{\sigma^{-1}(b)},\epsilon_{\sigma^{-1}(b)})} \\ \downarrow Z_T & & \swarrow Z_{\sigma(T)} \\ P_{(k_0,\epsilon_0)} & & \end{array}$$

Figure 2.2: Renumbering compatibility

where  $U_\sigma : \otimes_{j=1}^b P_{(k_j, \epsilon_j)} \longrightarrow \otimes_{j=1}^b P_{(k_{\sigma^{-1}(j)}, \epsilon_{\sigma^{-1}(j)})}$  is the linear isomorphism given by  $U_\sigma(\otimes_{j=1}^b x_j) = \otimes_{j=1}^b x_{\sigma^{-1}(j)}$  for  $\otimes_{j=1}^b x_j \in \otimes_{j=1}^b P_{(k_j, \epsilon_j)}$ .

**Compatibility with Composition:** Given tangles  $T = T_{(k_1, \epsilon_1), (k_2, \epsilon_2), \dots, (k_b, \epsilon_b)}^{(k_0, \epsilon_0)}$  and  $S = S_{(\tilde{k}_1, \tilde{\epsilon}_1), (\tilde{k}_2, \tilde{\epsilon}_2), \dots, (\tilde{k}_{\tilde{b}}, \tilde{\epsilon}_{\tilde{b}})}^{(\tilde{k}_0, \tilde{\epsilon}_0)}$  such that colour of the  $i$ -th internal disc of  $T$  is same as the colour of the external disc of  $S$  i.e.,  $(\tilde{k}_0, \tilde{\epsilon}_0) = (k_i, \epsilon_i)$ . Consider  $T \circ_i S$ . Then compatibility requirement for the tangle maps is that the following diagram commutes:

When  $\tilde{b} > 0$ :

$$\begin{array}{ccc}
(\otimes_{j=1}^{i-1} P_{(k_j, \epsilon_j)}) \otimes (\otimes_{j=1}^{\tilde{b}} P_{(\tilde{k}_j, \tilde{\epsilon}_j)}) \otimes (\otimes_{j=i+1}^b P_{(k_j, \epsilon_j)}) & & \\
(\otimes_{j=1}^{i-1} Id_{P_{(k_j, \epsilon_j)}}) \otimes Z_S \otimes (\otimes_{j=i+1}^b Id_{P_{(k_j, \epsilon_j)}}) \downarrow & \searrow^{Z_{T \circ_i S}} & \\
(\otimes_{j=1}^b P_{(k_j, \epsilon_j)}) & \xrightarrow{Z_T} & P_{(k_0, \epsilon_0)}
\end{array}$$

Figure 2.3: Compatibility condition when  $\tilde{b} > 0$

When  $\tilde{b} = 0$ :

$$\begin{array}{ccc}
(\otimes_{j=1}^{i-1} P_{(k_j, \epsilon_j)}) \otimes \mathbb{C} \otimes (\otimes_{j=i+1}^b P_{(k_j, \epsilon_j)}) & \xrightarrow{\cong} & \otimes_{\substack{j=1, \\ j \neq i}}^b P_{(k_j, \epsilon_j)} \\
(\otimes_{j=1}^{i-1} Id_{P_{(k_j, \epsilon_j)}}) \otimes Z_S \otimes (\otimes_{j=i+1}^b Id_{P_{(k_j, \epsilon_j)}}) \downarrow & & \downarrow Z_{T \circ_i S} \\
(\otimes_{j=1}^b P_{(k_j, \epsilon_j)}) & \xrightarrow{Z_T} & P_{(k_0, \epsilon_0)}
\end{array}$$

Figure 2.4: Compatibility condition when  $\tilde{b} = 0$

**Non-degeneracy axiom:** This axiom says that  $Z_{I_{k, \epsilon}^P} = Id_{P_{(k, \epsilon)}}$ , for all  $(k, \epsilon) \in Col$ .

We now define morphism of planar algebras.

**Definition 2.3.1.** If  $P, Q$  are planar algebras, a morphism from  $P$  to  $Q$  is a collection  $\{\phi_{(k, \epsilon)} : P_{(k, \epsilon)} \longrightarrow Q_{(k, \epsilon)}\}_{(k, \epsilon) \in Col}$  of linear maps such that given any tangle

$T = T_{(k_1, \epsilon_1), (k_2, \epsilon_2), \dots, (k_b, \epsilon_b)}^{(k_0, \epsilon_0)}$ , the following diagram commutes:

$$\begin{array}{ccc}
 \otimes_{j=1}^b P_{(k_j, \epsilon_j)} & \xrightarrow{Z_T^P} & P_{(k_0, \epsilon_0)} \\
 \otimes_{j=1}^b \phi_{(k_j, \epsilon_j)} \downarrow & & \downarrow \phi_{(k_0, \epsilon_0)} \\
 \otimes_{j=1}^b Q_{(k_j, \epsilon_j)} & \xrightarrow{Z_T^Q} & Q_{(k_0, \epsilon_0)}
 \end{array}$$

Figure 2.5: Planar algebra morphism

We remark that the above definition of planar algebras is the most recent one. We will refer to planar algebras in the older sense as restricted planar algebras. For these, the set of colours is the subset  $\{(0, \pm), (1, +), (2, +), \dots\}$ , all discs (with the exception of  $(0, -)$ -discs) have  $*$ -arcs abutting white regions and  $P$  is a collection of vector spaces indexed only by the subset above. Clearly, a planar algebra naturally yields a restricted planar algebra (which we will refer to as its restriction) in the obvious manner. The converse holds too in the following form - see Remark 3.6 of [5] (which treats the case when  $P$  has modulus).

**Proposition 2.3.2.** *Let  $Q$  be a restricted planar algebra. There exists a planar algebra  $P$  with restriction isomorphic to  $Q$ . Further  $P$  is unique in the sense that if  $P^1$  and  $P^2$  are planar algebras with restrictions  $Q^1$  and  $Q^2$  that are isomorphic (as restricted planar algebras) by the map  $\phi : Q^1 \rightarrow Q^2$ , then, there exists a unique planar algebra isomorphism  $\tilde{\phi} : P^1 \rightarrow P^2$  that restricts to  $\phi$ .*

*Proof.* For existence, given  $Q$ , construct  $P$  as follows. Define  $P_{0, \pm} = Q_{0, \pm}$  and for  $k > 0$ , set  $P_{k, \pm} = Q_{k, +}$ .

To define the action by tangles, first consider for every colour  $(k, \epsilon)$ , the tangle  $C^{(k, \epsilon)}$  which is defined to be the identity tangle of colour  $(k, \epsilon)$  if  $(k, \epsilon) \in \{(0, \pm), (1, +), (2, +), \dots\}$  and to be the one-rotation tangle with an internal disc of colour  $(k, +)$  and external disc of colour  $(k, -)$  otherwise. Also consider the

tangle  $D_{(k,\epsilon)}$  which is defined to be the identity tangle of colour  $(k, \epsilon)$  if  $(k, \epsilon) \in \{(0, \pm), (1, +), (2, +), \dots\}$  and to be the inverse one-rotation tangle with an internal disc of colour  $(k, -)$  and external disc of colour  $(k, +)$  otherwise.

Now, for a  $(k_0, \epsilon_0)$ -tangle  $T$  with internal discs of colours  $(k_1, \epsilon_1), \dots, (k_b, \epsilon_b)$ , define  $Z_T^P = Z_{\tilde{T}}^Q$  where  $\tilde{T} = D_{(k_0, \epsilon_0)} \circ T \circ_{(D_1, \dots, D_b)} (C^{(k_1, \epsilon_1)}, C^{(k_2, \epsilon_2)}, \dots, C^{(k_b, \epsilon_b)})$ . It is then easy to see that this defines a planar algebra structure on  $P$ , the main observation being that  $C^{(k, \epsilon)} \circ D_{(k, \epsilon)}$  is the identity tangle of colour  $(k, \epsilon)$ .

For uniqueness of  $P$ , suppose that  $P^1, P^2$  are planar algebras with restrictions  $Q^1, Q^2$  and  $\phi : Q^1 \rightarrow Q^2$  is a restricted planar algebra isomorphism. We need to see the existence and uniqueness of a unique planar algebra isomorphism  $\tilde{\phi} : P^1 \rightarrow P^2$  that restricts to  $\phi$ .

The uniqueness of  $\tilde{\phi}$  is because, given a colour  $(k, -)$  with  $k > 0$ , the equation  $\tilde{\phi}_{k,-} \circ Z_{C^{(k,-)}}^{P^1} = Z_{C^{(k,-)}}^{P^2} \circ \phi_{k,+}$ , must hold and  $Z_{C^{(k,-)}}^{P^1}$  is an isomorphism for any planar algebra  $P$ . As for existence, define  $\tilde{\phi}_{k,-}$  by the same equation and check that this indeed gives a planar algebra isomorphism that restricts to  $\phi$ .  $\square$

Given a planar algebra  $P$ , the following proposition describes the unital algebra structure on each vector space  $P_{(k,\epsilon)}$ . See Figure 2.1 for the tangles referenced here.

**Proposition 2.3.3.** *Let  $P$  be a planar algebra. Then for every colour  $(k, \epsilon)$ , the vector space  $P_{(k,\epsilon)}$  has the natural structure of an associative unital algebra with multiplication specified by the  $(k, \epsilon)$ -multiplication tangle  $M_{(k,\epsilon),(k,\epsilon)}^{(k,\epsilon)}$  and unit given by  $Z_{U^{k,\epsilon}}(1)$  where  $U^{k,\epsilon}$  is the unit tangle (see figure 2.1 for definitions of  $M_{(k,\epsilon),(k,\epsilon)}^{(k,\epsilon)}$  and  $U^{k,\epsilon}$ ). Furthermore, inclusion tangles induce homomorphisms of unital algebras.*

We now recall certain significant properties of planar algebras.

- **Connectedness:** A planar algebra  $P$  is said to be connected if  $\dim P_{(0,\pm)} = 1$ . In this case, there are canonical identifications  $P_{(0,\pm)} \cong \mathbb{C}$ .

- **Modulus:** A connected planar algebra  $P$  is said to have modulus  $\delta$  if there is a scalar  $\delta$  such that  $Z_{T^0, \pm}^P = \delta Id_{\mathbb{C}}$  where  $T^{0,+}$  (resp.,  $T^{0,-}$ ) denotes the  $(0, +)$  (resp.,  $(0, -)$ ) tangle with no internal disc and a single closed loop.

**Remark 2.3.4.** *If a connected planar algebra has nonzero modulus, then inclusion tangles induce injective maps.*

- **Finite-dimensionality:** A planar algebra  $P$  is said to be finite dimensional if  $\dim P_{(k, \epsilon)} < \infty$ , for all  $(k, \epsilon) \in Col$ .

- **Sphericity:** A connected planar algebra is spherical if and only if  $Z_{EL_{1,+}^{0,-}}^P = Z_{TR_{1,+}^{0,+}}^P$  (see figure 2.1 for definitions of  $EL_{1,+}^{0,-}$  and  $TR_{1,+}^{0,+}$ ), where both  $Z_{EL_{1,+}^{0,-}}^P$  and  $Z_{TR_{1,+}^{0,+}}^P$  are regarded as linear functionals on  $P_{(1,+)}$ .

## 2.4 Universal planar algebras and presentations

Given a ‘label set’  $L = \coprod_{(k, \epsilon) \in Col} L_{(k, \epsilon)}$ , an  $L$ -labelled tangle is a pair  $(T, f)$  where  $T$  is a tangle, say,  $T = T_{(k_1, \epsilon_1), (k_2, \epsilon_2), \dots, (k_b, \epsilon_b)}^{(k_0, \epsilon_0)}$  and  $f$  is a function from  $\{D_1(T), D_2(T), \dots, D_b(T)\}$  to  $L$  such that  $f(D_i(T)) \in L_{(k_i, \epsilon_i)}$  for all  $i$ . Thus by an  $L$ -labelled tangle we simply mean a tangle each of whose internal discs of colour  $(k, \epsilon)$  is labelled by an element of  $L_{(k, \epsilon)}$ . Thus if  $L_{(k, \epsilon)} = \emptyset$  for some colour  $(k, \epsilon)$ , then no  $L$ -labelled tangle can have an internal disc of colour  $(k, \epsilon)$ .

The universal planar algebra on  $L$ , denoted by  $P(L)$ , is defined by requiring that  $P(L)_{(k, \epsilon)}$  is the vector space with basis all  $L$ -labelled  $(k, \epsilon)$  tangles with the action of a planar tangle on a tensor product of basis vectors is given by the obvious  $L$ -labelled tangle obtained by substituting these basis vectors into the appropriate internal discs.

We now introduce the notion of a planar ideal.

**Definition 2.4.1.** *A planar ideal  $I$  of a planar algebra  $P$  is a collection  $\{I_{(k, \epsilon)} : (k, \epsilon) \in Col\}$*

$(k, \epsilon) \in Col\}$  of vector spaces where each  $I_{(k, \epsilon)}$  is a linear subspace of  $P_{(k, \epsilon)}$  such that given any tangle  $T = T_{(k_1, \epsilon_1), (k_2, \epsilon_2), \dots, (k_b, \epsilon_b)}^{(k_0, \epsilon_0)}$ ,  $Z_T(\otimes_{j=1}^b x_j) \in I_{(k_0, \epsilon_0)}$  whenever  $x_j \in I_{(k_j, \epsilon_j)}$  for some  $j, 1 \leq j \leq b$ .

Given a planar ideal  $I$  in a planar algebra  $P$ , there is a natural planar algebra structure on the quotient  $P/I = \{(P/I)_{(k, \epsilon)} := P_{(k, \epsilon)}/I_{(k, \epsilon)} : (k, \epsilon) \in Col\}$  together with a surjective planar algebra morphism from  $P$  to  $P/I$ .

Given a planar algebra  $P$ , let  $R = \{R_{(k, \epsilon)} : (k, \epsilon) \in Col\}$  be a subset of  $P$  (i.e., each  $R_{(k, \epsilon)}$  is a subset of  $P_{(k, \epsilon)}$ ). The planar ideal generated by  $R$ , denoted by  $I(R)$ , is the smallest planar ideal in  $P$  containing  $R$ . Equivalently, if we set  $I_{(k, \epsilon)}$  to be the span of all  $Z_T(x_1 \otimes \dots \otimes x_b)$  where  $T$  is a  $(k, \epsilon)$ -tangle, say  $T = T_{(k_1, \epsilon_1), (k_2, \epsilon_2), \dots, (k_b, \epsilon_b)}^{(k, \epsilon)}$ , and at least one  $x_i \in R$ , then  $I = \{I_{(k, \epsilon)} : (k, \epsilon) \in Col\}$  is the planar ideal generated by  $R$ .

We now describe the notion of planar algebra presented with generators and relations.

**Definition 2.4.2.** *Given a label set  $L = \coprod_{(k, \epsilon) \in Col} L_{(k, \epsilon)}$ , consider the universal planar algebra  $P(L)$  on  $L$ . Let  $R$  be a subset of  $P(L)$  and suppose  $I(R)$  denotes the planar ideal generated by  $R$ . The quotient planar algebra  $P(L)/I(R)$  is said to be the planar algebra presented with generators  $L$  and relations  $R$  and is usually denoted by  $P(L, R)$ .*

## 2.5 The planar algebra of a Hopf algebra

Throughout this section  $k$  will denote an algebraically closed field. We recall from [16] the construction of the planar algebra associated to a finite dimensional semisimple and cosemisimple Hopf algebra  $H$  of dimension  $n$  over  $k$ . The nonzero idempotent integrals of  $H^*$  and  $H$  are denoted by  $p$  and  $h$  respectively.

However, the definition depends on the choice of a square root, denoted  $\delta$ , of  $n$  in  $k$ , which we will assume has been made and is fixed throughout. The planar algebra  $P(H, \delta)$  (which we will simply write as  $P(H)$ ) is then defined to be the planar algebra  $P(L, R)$  where

$$L_{(k, \epsilon)} = \begin{cases} H, & \text{if } (k, \epsilon) = (2, +) \\ \emptyset, & \text{otherwise} \end{cases}$$

and  $R$  being given by the set of relations in Figures 2.6 - 2.9 (where (i) we write the relations as identities - so the statement  $a = b$  is interpreted as  $a - b \in R$ ; (ii)  $\zeta \in k$  and  $a, b \in H$ ; and (iii) the external boxes of all tangles appearing in the relations are left undrawn and it is assumed that all external  $*$ -arcs are the leftmost arcs.

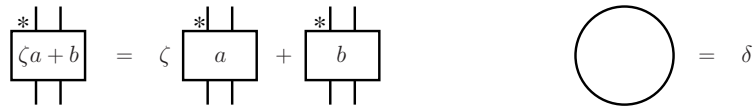

Figure 2.6: The L(inearity) and M(odulus) relations



Figure 2.7: The U(nit) and I(ntegral) relations



Figure 2.8: The C(ounit) and T(race) relations

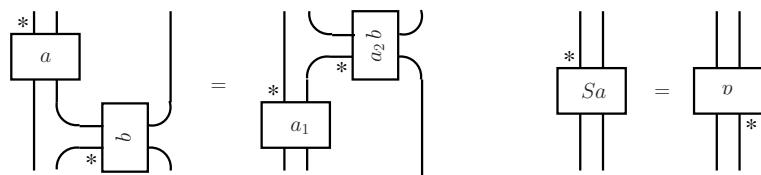

Figure 2.9: The E(xchange) and A(ntipode) relations

In these figures, note that the shading is such that all the 2-boxes that occur are of colour  $(2, +)$ . Also note that the modulus relation is a pair of relations - one for each choice of shading the circle.

The main result of [16] asserts the following.

**Theorem 2.5.1.** *Let  $H$  be a semisimple and cosemisimple Hopf algebra  $H$  of dimension  $n$ . The planar algebra  $P(H, \delta)$  associated to  $H$  is a connected, irreducible, spherical, non-degenerate planar algebra with modulus  $\delta$  and of depth two. Further,  $\dim P_{(k, \epsilon)} = n^{k-1}$  for all  $k \geq 1$ .*

**Remark 2.5.2.** *The word ‘non-degenerate’ here refers not to the non-degeneracy axiom (which must hold for any planar algebra) but to the condition that the trace tangles for each colour specify non-degenerate traces.*

We recall a result from [16]. Let  $\mathcal{T}(k, \epsilon)$  denote the set of  $(k, \epsilon)$  tangles with  $k-1$  (interpreted as 0 for  $k=0$ ) internal boxes of colour  $(2, +)$  and no ‘internal regions’. The result then asserts:

**Lemma 2.5.3.** *[Lemma 16 of [16]] For each tangle  $X \in \mathcal{T}(k, \epsilon)$ , the map  $Z_X^{P(H)} : (P_{(2,+)}(H))^{\otimes(k-1)} \rightarrow P_{(k,\epsilon)}(H)$  is an isomorphism.*

While the statement in [16] assumes  $\epsilon = 1$  and  $k \geq 3$ , it is easy to see that neither restriction is really necessary.

The following lemma establishes algebra isomorphisms between  $P(H)_{k,\pm}$  and finite iterated crossed product algebras.

**Lemma 2.5.4.** *Let  $H$  be a finite-dimensional, semisimple and cosemisimple Hopf algebra over  $k$  with planar algebra  $P(H)$ . For each  $k \geq 2$  the maps*

$$\begin{aligned} H \rtimes H^* \rtimes H \rtimes \cdots (k-1 \text{ factors}) &\longrightarrow P(H)_{k,+} \text{ and} \\ H^* \rtimes H \rtimes H^* \rtimes \cdots (k-1 \text{ factors}) &\longrightarrow P(H)_{k,-}, \end{aligned}$$



defined as in Figure 2.10 are algebra isomorphisms where  $F$  ( $= F_{\delta p}$ ) denotes the

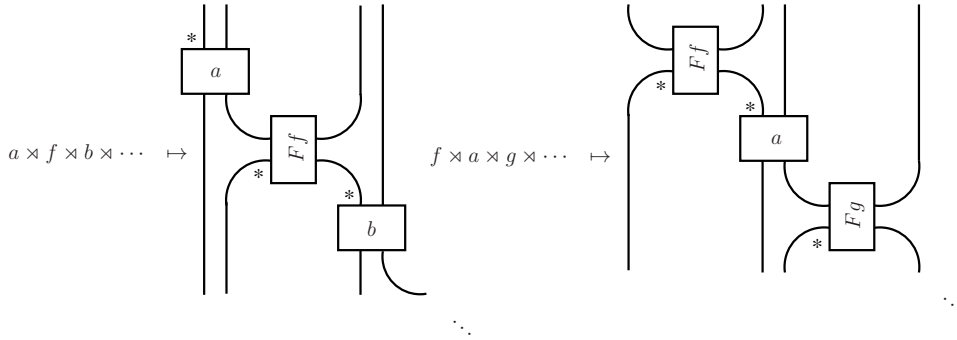

Figure 2.10: Algebra isomorphisms

Fourier transform map from  $H$  to  $H^*$  defined by  $F(a) = \delta p_1(a)p_2$ .

## 2.6 Cabling

For any positive integer  $m$ , consider the ‘operation  $T \mapsto T^{(m)}$  on tangles’ given by  $m$ -cabling. Some care is needed in defining this for tangles involving  $(k, \epsilon)$  boxes with  $\epsilon = -1$ . Take the tangle  $T$ , ignore its shading and thicken every strand to a cable of  $m$  parallel strands without changing the  $*$ ’s. Now introduce shading in the result such that any  $(k, \epsilon)$  box of  $T$  changes to a  $(mk, \epsilon^m)$  box of  $T^{(m)}$ . A little thought shows that this does give a consistent checkerboard shading as needed. For a detailed definition of ‘operation on tangles’, see [15]. This gives an operation on planar algebras  $P \mapsto {}^{(m)}P$ . Here, the planar algebra  ${}^{(m)}P = Q$ , say, is defined by setting the vector spaces  $Q_{k, \pm}$  to be  $P_{mk, (\pm)^m}$  and the action  $Z_T^Q$  of a tangle  $T$  on  $Q$  to be  $Z_{T^{(m)}}^P$ .

In our case we will only be interested in the 2-cabling of a planar algebra  $P$  whose spaces are specified by  ${}^{(2)}P_{k, \pm} = P_{2k, +}$  for any  $k \in \{0, 1, 2, \dots\}$ .

# Chapter 3

## Infinite iterated crossed products and Drinfeld doubles

The purpose of this chapter is to prove one of our main results which is roughly the following: Given a finite dimensional Hopf algebra over any field, we associate to it a very natural inclusion  $A \subseteq B$  of infinite iterated crossed product algebras, namely,  $B = H^{op(-\infty, \infty)} = \dots \rtimes H^{op} \rtimes H^{op*} \rtimes H^{op} \rtimes \dots$  and  $A = H^{op(-\infty, -1]} \otimes H^{op[2, \infty)}$ . We then show that  $B$  is the crossed product of  $A$  by  $D(H)$  where  $D(H)$  denotes the Drinfeld double of  $H$ . More significantly, we show that  $D(H)$  is the only finite-dimensional Hopf algebra with this property and thus produce a context in which the Drinfeld double arises very naturally.

Though motivated by a folklore result in subfactor theory which asserts that for a Kac algebra subfactor, a related subfactor to its asymptotic inclusion comes from an outer action of its Drinfeld double, it is worth noting that our main result is purely algebraic in nature and applies to finite dimensional Hopf algebras over an arbitrary field. In particular, it applies to Hopf algebras that are not semisimple, in contrast to the analytic case.

### 3.1 Iterated crossed products

Throughout we work over a fixed but arbitrary ground field  $k$ . All algebras considered here will be unital  $k$ -algebras and possibly infinite-dimensional. However, the Hopf algebras we consider will always be finite-dimensional. Subalgebras will always refer to unital subalgebras.

We begin with the definition of action of a finite-dimensional Hopf algebra on an algebra.

**Definition 3.1.1.** *Suppose that  $A$  is an algebra and  $H = (H, \mu, \eta, \Delta, \epsilon, S)$  is a finite-dimensional Hopf algebra. By an action of  $H$  on  $A$  we will mean a linear map  $\alpha : H \rightarrow \text{End}(A)$  (references to endomorphisms without further qualification will be to  $k$ -linear endomorphisms) satisfying (i)  $\alpha_1 = \text{id}_A$ , (ii)  $\alpha_{xy} = \alpha_x \circ \alpha_y$ , (iii)  $\alpha_x(1_A) = \epsilon(x)1_A$  and (iv)  $\alpha_x(ab) = \alpha_{x_1}(a)\alpha_{x_2}(b)$ , for all  $x, y \in H$  and  $a, b \in A$ . To clarify notation,  $\alpha_x$  stands for  $\alpha(x)$  and  $\Delta(x)$  is denoted by  $x_1 \otimes x_2$ .*

**Example 3.1.2.** *Given a finite-dimensional Hopf algebra  $H$ , consider the dual Hopf algebra  $H^*$ . There is a natural action of  $H^*$  on  $H$  given by  $\beta_f(x) = f(x_2)x_1$  for  $f \in H^*, x \in H$ . Similarly we have action of  $H$  on  $H^*$ .*

We draw the reader's attention to a notational abuse of which we will often be guilty. We denote elements of a tensor product as decomposable tensors with the understanding that there is an implied omitted summation (just as in our simplified Sweedler notation). Thus, when we write 'suppose  $f \otimes x \in H^* \otimes H$ ', we mean 'suppose  $\sum_i f^i \otimes x^i \in H^* \otimes H$ ' (for some  $f^i \in H^*$  and  $x^i \in H$ , the sum over a finite index set).

If  $H$  acts on  $A$ , we may define the crossed product algebra (or the smash product algebra) as follows.

**Definition 3.1.3.** *Given an action  $\alpha$  of  $H$  on  $A$ , the crossed product algebra, denoted  $A \rtimes_{\alpha} H$  (or mostly, simply as  $A \rtimes H$ , when the action is understood) to be the algebra*

with underlying vector space  $A \otimes H$  (where we denote  $a \otimes x$  by  $a \rtimes x$ ) and multiplication defined by

$$(a \rtimes x)(b \rtimes y) = a\alpha_{x_1}(b) \rtimes x_2y.$$

This is an algebra with unit  $1_A \rtimes 1_H$  and there are natural inclusions of algebras  $A \subseteq A \rtimes H$  given by  $a \mapsto a \rtimes 1_H$  and  $H \subseteq A \rtimes H$  given by  $x \mapsto 1_A \rtimes x$ . We note that while the crossed or smash product construction is a special case of one that involves, in addition, twisting by a 2-cocycle of  $H$ , in our context, it suffices to consider the case of the trivial cocycle, which is the one discussed above.

Borrowing terminology from subfactor theory, we define an inclusion  $A \subseteq B$  of algebras to be irreducible if the relative commutant  $A' \cap B$  (which is the centraliser algebra of  $A$  in  $B$ , also denoted by  $C_B(A)$  or  $B^A$ ) is just  $k1_B$ , i.e., if the only elements of  $B$  that commute with all elements of  $A$  are scalar multiples of its identity element. We also define an action of  $H$  on  $A$  to be outer if the inclusion  $A \subseteq A \rtimes H$  is irreducible.

The following lemma, whose proof we omit, is a simple and useful characterisation of crossed products without explicit reference to an action. We will say that two algebras containing an algebra  $A$  are isomorphic as algebras over  $A$ , if they are isomorphic by an isomorphism that restricts to the identity on  $A$ .

**Lemma 3.1.4.** *Suppose that  $B$  is an algebra with subalgebras  $A$  and  $H$ , where  $H$  is further equipped with a comultiplication and antipode that make it a Hopf algebra, and such that:*

- (i) *The restriction of the multiplication map  $\mu : A \otimes H \rightarrow B$  is a linear isomorphism, and*
- (ii) *For all  $x \in H$  and  $a \in A$ ,  $x_1aSx_2 \in A$ .*

*Then  $\alpha : H \rightarrow \text{End}(A)$  defined by  $\alpha_x(a) = x_1aSx_2$  is an action of  $H$  on  $A$  and the*

crossed product algebra  $A \rtimes_{\alpha} H$  is isomorphic to  $B$  as an algebra over  $A$ .  $\square$

Observe that if  $\alpha$  is an action of a Hopf algebra  $H$  on an algebra  $A$ , then there is a natural action  $\beta$  of the dual Hopf algebra  $H^*$  on the crossed product algebra  $A \rtimes H$  defined by  $\beta_f(a \rtimes x) = f(x_2)(a \rtimes x_1)$ . In the sequel, we will use this action without further specification.

We now review infinite iterated crossed products. Our treatment closely follows that of [7] which treats the case when  $H$  is a Kac algebra. For  $i \in \mathbb{Z}$ , define  $H^i$  to be  $H^*$  or  $H$  according as  $i$  is even or odd. For  $i \leq j$  define  $H^{[i,j]}$  by induction on  $j - i$  as  $H^i$  if  $j = i$  and as  $H^{[i,j-1]} \rtimes H^j$  otherwise (for the natural action). The multiplication on  $H^{[i,j]}$  is seen (by induction) to be given by the following formula (when  $i, j$  are both even - similar formulae hold for the other three cases):

$$\begin{aligned} & (f^i \rtimes x^{i+1} \rtimes \cdots \rtimes f^j)(g^i \rtimes y^{i+1} \rtimes \cdots \rtimes g^j) = \\ & \langle x_1^{i+1} | g_2^i \rangle \langle f_1^{i+2} | y_2^{i+1} \rangle \cdots \langle x_1^{j-1} | g_2^{j-2} \rangle \langle f_1^j | y_2^{j-1} \rangle \times \\ & f^i g_1^i \rtimes x_2^{i+1} y_1^{i+1} \rtimes \cdots \rtimes x_2^{j-1} y_1^{j-1} \rtimes f_2^j g^j. \end{aligned}$$

The multiplication is given pictorially in Figure 3.1. The interpretation of Figure

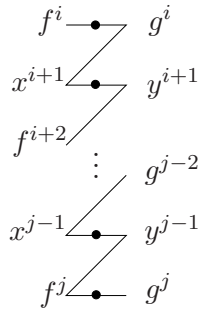

Figure 3.1: Multiplication in  $H^{[i,j]}$  for  $i, j$  even

3.1 is as follows. The dots are to be interpreted as multiplication (in  $H$  or in  $H^*$ ), the diagonal lines as contractions (between  $H$  and  $H^*$  to get a constant) and the forks as applications of  $\Delta$ .

Note that  $H^{[i,i+1]} = H^i \rtimes H^{i+1}$  is known as the Heisenberg double of  $H^i$  (and is isomorphic to a matrix algebra of size  $\dim(H)$ ).

The multiplication rule shows that if  $p \leq i \leq j \leq q$ , the natural inclusion of  $H^{[i,j]}$  into  $H^{[p,q]}$  is an algebra map. Define the algebra  $B$  to be the ‘union’ of all the  $H^{[i,j]}$ . More precisely,  $B$  is the direct limit, over the subset of finite intervals in  $\mathbb{Z}$  directed by inclusion, of the  $H^{[i,j]}$ . We may suggestively write  $B = H^{(-\infty,\infty)} = \cdots \rtimes H \rtimes H^* \rtimes H \rtimes \cdots$  and represent a typical element of  $B$  as  $\cdots \rtimes x^{-1} \rtimes f^0 \rtimes x^1 \rtimes \cdots$ . We repeat that this means that a typical element of  $B$  is in fact a finite sum of such terms. Note that in any such term all but finitely many of the  $f^i$  are  $\epsilon$  and all but finitely many of the  $x^i$  are 1. One fact about the infinite iterated crossed product that we will use is that  $H^i$  and  $H^j$  commute whenever  $|i - j| \geq 2$ .

Next, we define a subalgebra  $A$  of  $B$  which, in suggestive notation, is  $H^{(-\infty,-1]} \otimes H^{[2,\infty)}$ . A little more clearly, it consists of all (finite sums of) elements  $\cdots \rtimes x^{-1} \rtimes f^0 \rtimes x^1 \rtimes \cdots$  of  $B$  with  $f^0 = \epsilon$  and  $x^1 = 1$ . Strictly speaking, if  $H^{(-\infty,-1]}$  represents the direct limit of all the  $H^{[-j,-1]}$  for  $j \geq 1$  and  $H^{[2,\infty)}$  represents the direct limit of all the  $H^{[2,j]}$  for  $j \geq 2$ , then, these algebras can be identified with commuting subalgebras of  $B$ , with the multiplication map being an injective map from  $H^{(-\infty,-1]} \otimes H^{[2,\infty)}$  to  $B$ , and the image is denoted  $A$ . As an algebra,  $A$  is clearly generated by all the  $H^i$  for  $i \in \mathbb{Z} \setminus \{0, 1\}$ .

The main object of interest is the following pair of algebras.

**Definition 3.1.5.** *For a finite-dimensional Hopf algebra  $H$ , the inclusion  $A \subseteq B$  of (infinite-dimensional) algebras defined above will be called the derived pair of  $H$ .*

The following proposition identifying the relative commutant of the derived pair will be very useful. In case  $H$  is a Kac algebra, this appears in [6].

**Proposition 3.1.6.** *For any  $p \in \mathbb{Z}$ , the subalgebras  $H^{(-\infty,p]}$  and  $H^{[p+2,\infty)}$  are mutual commutants in  $B$ . In particular, the derived pair of  $H$  is irreducible.*

The main observation in the proof of Proposition 3.1.6 is contained in the following lemma, for the proof of which we need to recall a few facts regarding integrals as well as Fourier transforms of a finite dimensional Hopf algebra for which we refer to Theorem 1.2.4, Lemma 1.2.6, and Remark 1.2.11.

**Lemma 3.1.7.** *For  $i \leq j$ , the set of elements of  $H^{[i,j]}$  that commute with a non-zero left integral in  $H^{i-1}$  is precisely  $H^{[i+1,j]}$ .*

*Proof.* First suppose that  $i$  is even, so that  $H^{i-1} = H$ . Since elements of  $H^{[i+1,j]}$  certainly commute with all elements of  $H^{i-1}$ , it suffices to see that an arbitrary element, say  $f^i \rtimes x^{i+1} \rtimes \dots \in H^{[i,j]}$  that commutes with a non-zero left integral, say  $h^{i-1} \in H^{i-1}$ , is actually in  $H^{[i+1,j]}$ .

The commutativity condition is equivalent to the equation

$$h^{i-1} \rtimes f^i \rtimes x^{i+1} \rtimes \dots = f_1^i(h_2^{i-1})h_1^{i-1} \rtimes f_2^i \rtimes x^{i+1} \rtimes \dots.$$

Comparing coefficients of a basis of  $H^{[i+1,j]}$  on both sides, we get  $h^{i-1} \rtimes f^i = f_1^i(h_2^{i-1})h_1^{i-1} \rtimes f_2^i$ . Evaluating the second component on 1 gives  $f^i(1)h^{i-1} = f^i(h_2^{i-1})h_1^{i-1}$ . But now, since  $f^i(1)h^{i-1} = f^i(1)\epsilon(h_2^{i-1})h_1^{i-1}$ , the injectivity of the Fourier transform map implies that  $f^i = f^i(1)\epsilon$ . Therefore  $f^i \rtimes x^{i+1} \rtimes \dots \in H^{[i+1,j]}$ , as desired.

A similar proof is valid if  $i$  is odd, replacing  $H$  with  $H^*$ . □

*Proof of Proposition 3.1.6.* Since  $H^i$  and  $H^j$  commute for  $|i-j| \geq 2$ , the subalgebras  $H^{(-\infty,p]}$  and  $H^{[p+2,\infty)}$  of  $B$  commute with each other and therefore are contained in the commutants of one another.

To show that  $(H^{(-\infty,p]})' \subseteq H^{[p+2,\infty)}$ , take  $1 \neq b \in (H^{(-\infty,p]})'$ , and choose  $i$  largest so that  $b \in H^{[i,j]}$  for some  $j$ . It suffices to see that  $i \geq p+2$ . Suppose that  $i \leq p+1$  so that  $i-1 \leq p$ . Now  $b \in H^{[i,j]}$  and commutes with  $H^{i-1}$  (since  $H^{i-1} \subseteq H^{(-\infty,p]}$ ). By Lemma 3.1.7 it follows that  $b \in H^{[i+1,j]}$  contradicting choice of  $i$ .

To see that  $(H^{[p+2,\infty)})' \subseteq H^{(-\infty,p]}$ , note that the ‘flip map about  $p + 1$ ’ from  $B$  to  $B$  defined by

$$\begin{aligned} & \dots \rtimes f^{p-1} \rtimes x^p \rtimes f^{p+1} \rtimes x^{p+2} \rtimes f^{p+3} \rtimes \dots \\ \mapsto & \dots \rtimes S f^{p+3} \rtimes S^{-1} x^{p+2} \rtimes S f^{p+1} \rtimes S^{-1} x^p \rtimes S f^{p-1} \rtimes \dots \end{aligned}$$

(for  $p$  odd, with a similar definition for  $p$  even) is an anti-automorphism that interchanges  $H^{[p+2,\infty)}$  and  $H^{(-\infty,p]}$  and appeal to the previously proved case.

Finally, to see irreducibility of the derived pair, note that  $A' \cap B = (H^{(-\infty,-1)})' \cap (H^{[2,\infty)})' = H^{[1,\infty)} \cap H^{(-\infty,0]} = k1_B$  - as desired.  $\square$

## 3.2 The Drinfeld double construction

We next review the Drinfeld double construction from [19]. The Drinfeld double of a Hopf algebra  $H$ , denoted  $D(H)$ , is the Hopf algebra whose underlying vector space is  $H^* \otimes H$  and multiplication, comultiplication and antipode specified by the following formulae.

$$\begin{aligned} (f \otimes x)(g \otimes y) &= g_1(Sx_1)g_3(x_3)(g_2f \otimes x_2y), \\ \Delta(f \otimes x) &= (f_1 \otimes x_1) \otimes (f_2 \otimes x_2), \text{ and} \\ S(f \otimes x) &= f_1(x_1)f_3(Sx_3)(S^{-1}f_2 \otimes Sx_2). \end{aligned}$$

What we actually use is an isomorphic avatar of this, which we denote  $\tilde{D}(H)$  which also has underlying vector space  $H^* \otimes H$  and structure maps obtained by transporting the structures on  $D(H)$  using the invertible map  $S \otimes S^{-1} : D(H) = H^* \otimes H \rightarrow H^* \otimes H = \tilde{D}(H)$ . It is easily checked that the structure maps for  $\tilde{D}(H)$  are given



by the following formulae.

$$\begin{aligned}
(f \otimes x)(g \otimes y) &= g_1(x_1)g_3(Sx_3)(fg_2 \otimes yx_2), \\
\Delta(f \otimes x) &= (f_2 \otimes x_2) \otimes (f_1 \otimes x_1), \text{ and} \\
S(f \otimes x) &= f_1(Sx_1)f_3(x_3)(S^{-1}f_2 \otimes Sx_2).
\end{aligned}$$

The Hopf algebra  $\tilde{D}(H)^{cop}$  is the Hopf algebra (also with underlying space  $H^* \otimes H$ ) with structure maps given by:

$$\begin{aligned}
(f \otimes x)(g \otimes y) &= g_1(x_1)g_3(Sx_3)(fg_2 \otimes yx_2), \\
\Delta(f \otimes x) &= (f_1 \otimes x_1) \otimes (f_2 \otimes x_2), \text{ and} \\
S(f \otimes x) &= f_1(Sx_1)f_3(x_3)(Sf_2 \otimes S^{-1}x_2).
\end{aligned}$$

For ease of notation we will denote the Hopf algebra  $\tilde{D}(H)^{cop}$  by  $L$ . By construction, as a Hopf algebra, it is isomorphic to  $D(H)^{cop}$ .

**Lemma 3.2.1.**  $\tilde{D}(H^{cop}) \cong \tilde{D}(H)^{cop}$  as Hopf algebras.

*Proof.* It follows from the above that the structure maps for  $\tilde{D}(H^{cop})$  are given by:

$$\begin{aligned}
(f \otimes x)(g \otimes y) &= g_1(x_3)g_3(S^{-1}x_1)(g_2f \otimes yx_2), \\
\Delta(f \otimes x) &= (f_2 \otimes x_1) \otimes (f_1 \otimes x_2), \text{ and} \\
S(f \otimes x) &= f_1(S^{-1}x_3)f_3(x_1)(Sf_2 \otimes S^{-1}x_2).
\end{aligned}$$

A direct check now shows that the map  $S \otimes id_H : \tilde{D}(H)^{cop} \rightarrow \tilde{D}(H^{cop})$  is a Hopf algebra isomorphism.  $\square$

### 3.3 Basic construction, crossed products and recognition

This section is devoted to a few results that will be used in proving the uniqueness part of our main theorem. We use the notion of ‘basic construction’ as the main tool towards proving this uniqueness result.

**Definition 3.3.1.** *The passage from a unital algebra inclusion  $A \subseteq B$  to the unital algebra inclusion  $B \subseteq C = \text{End}(B_A)$  (the algebra of right  $A$ -linear endomorphisms of  $B$ ) where the inclusion of  $B$  in  $C$  is via the left regular representation is called the basic construction of  $A \subseteq B$ .*

Many of the results of this section are known - sometimes in greater generality - for Hopf-Galois extensions (in particular for twisted smash products) as in [9, 17], including crossed product recognition theorems as in [3, 10]. Proofs are included here only for completeness.

**Lemma 3.3.2.** *Let  $A \subseteq B$  be a unital inclusion of algebras with associated basic construction  $B \subseteq C$ . Then the centraliser algebras  $B^A$  and  $C^B$  are anti-isomorphic. In particular,  $A \subseteq B$  is irreducible if and only if  $B \subseteq C$  is irreducible.*

*Proof.* The map  $B^A \rightarrow C^B$  given by  $b \mapsto \rho_b$  where  $\rho_b(\tilde{b}) = \tilde{b}b$  is verified to be an anti-isomorphism. □

Before we prove the next theorem analysing the basic construction when  $A \subseteq B$  is of the form  $A \subseteq A \rtimes H$ , we pause to observe the following.

**Lemma 3.3.3.** *Every linear map  $H \rightarrow A \rtimes H$  is of the form  $\lambda_{a \rtimes x} \beta_f$  for  $a \otimes x \otimes f \in A \otimes H \otimes H^*$ .*

*Proof.* Clearly, any such linear map is necessarily of the form  $z \mapsto a \otimes g(z)y$  for some  $a \otimes y \otimes g \in A \otimes H \otimes H^*$ . Let  $p$  be a left integral for  $H^*$  and  $h$  a left integral of

$H$  with  $p(h) = 1$ . Let  $a \otimes x \otimes f = a \otimes (gp_2)(h_2)yS^{-1}h_1 \otimes S^{-1}p_1$ . Now, computation, using the properties of left integrals stated above Lemma 3.1.7 applied to both  $h$  and  $p$ , shows that  $\lambda_{a \rtimes x} \beta_f(z) = a \otimes g(z)y$ , as desired.  $\square$

**Theorem 3.3.4.** *Suppose that  $\alpha$  is an action of the finite-dimensional Hopf algebra  $H$  on an algebra  $A$  and  $B = A \rtimes H$ . Let  $B \subseteq C$  be the basic construction of  $A \subseteq B$ . Then,*

(1)  $C$  is isomorphic as an algebra over  $B$  to  $B \rtimes H^*$ .

If, further, the action  $\alpha$  is outer, then

(2)  $A' \cap C (= \text{End}({}_A B_A)) = H^*$  for the natural imbedding of  $H^*$  in  $C$ , and

(3)  $\text{Hom}({}_A B_{A,A} A_A)$  is 1-dimensional and is identified in  $H^*$  as the scalar multiples of a (necessarily) non-zero left integral of  $H^*$ .

*Proof.* (1) Define a map  $\theta : B \rtimes H^* \rightarrow C$  by  $\theta(b \rtimes f) = \lambda_b \circ \beta_f$  and note that this a well-defined map, i.e., is right  $A$ -linear, and, after a little calculation, is an algebra homomorphism that restricts to the identity on  $B$ .

To see that  $\theta$  is injective, take  $Z = b \rtimes y \rtimes g \in B \rtimes H^* = A \rtimes H \rtimes H^*$  in  $\ker(\theta)$ . To see that  $Z = 0$ , it will suffice to see that for arbitrary  $f \in H^*$  and  $x \in H$ ,  $(\text{id} \otimes f \otimes x)(Z) = 0$ . Computation shows that  $0 = \theta(Z)(1 \rtimes z) = g(z_2)(b \rtimes y z_1)$ , for all  $z \in H$ . Hence, for all  $k \in H^*$  and  $z \in H$ ,  $g(z_2)k(y z_1)b = (\text{id} \otimes k_2(z_1)k_1 \otimes z_2)(Z) = 0$ . Now appeal to the well-known (and easily checked) fact that the map  $k \otimes z \mapsto k_2(z_1)k_1 \otimes z_2$  of  $H^* \otimes H$  to itself is invertible (with inverse  $f \otimes x \mapsto f_2(S^{-1}x_1)f_1 \otimes x_2$ ) to produce  $k \otimes z$  such that  $k_2(z_1)k_1 \otimes z_2 = f \otimes x$ , to finish the proof of injectivity.

For surjectivity, first note that the map  $x \otimes a \mapsto xa = (1 \rtimes x)(a \rtimes 1) = \alpha_{x_1}(a) \rtimes x_2 : H \otimes A \rightarrow A \rtimes H$  is a linear isomorphism with inverse given by  $a \rtimes x \mapsto x_2 \otimes \alpha_{S^{-1}x_1}(a)$ . It follows that any right  $A$ -linear map from  $B$  to  $B$  is determined by its action on

elements of  $H$ . Now by Lemma 3.3.3, an arbitrary linear map from  $H$  to  $A \rtimes H$  can be expressed in the form  $\lambda_{a \rtimes x} \beta_f$  for  $a \otimes x \otimes f \in A \otimes H \otimes H^*$ . Since  $\lambda_{a \rtimes x} \beta_f$  is right  $A$ -linear, surjectivity follows.

(2) Identify  $C$  with  $A \rtimes H \rtimes H^*$ . Observe first that  $1 \rtimes 1 \rtimes f$  commutes with  $A$  for all  $f \in H^*$ . Conversely, suppose that  $a \rtimes x \rtimes f \in A' \cap C$ . This implies that  $\tilde{a}a \rtimes x \rtimes f = a\alpha_{x_1}(\tilde{a}) \rtimes x_2 \rtimes f$  for all  $\tilde{a} \in A$ . Recalling that  $a \rtimes x \rtimes f$  actually stands for a sum and comparing coefficients of a basis of  $H^*$  on either side gives  $\tilde{a}a \rtimes x = a\alpha_{x_1}(\tilde{a}) \rtimes x_2$  for all  $\tilde{a} \in A$ . This implies that  $a \rtimes x \in A' \cap B$  and is therefore a scalar by outer-ness of the action. Hence  $a \rtimes x \rtimes f \in H^* \subseteq C$ .

(3)  $\text{Hom}({}_A B_{A,A} A_A)$  consists of those elements of  $\text{End}({}_A B_A)$  whose range is contained in  $A$ . Since  $\text{End}({}_A B_A) = \{\beta_f : f \in H^*\}$ , we need to see for what  $f \in H^*$  is  $\beta_f(A \rtimes H) \subseteq A$ . If  $f = p$  - a non-zero left integral of  $H^*$ , then  $\beta_f(a \rtimes x) = a \rtimes p(x_2)x_1 = p(x)(a \rtimes 1)$ , by the defining property of a left integral of  $H^*$ . On the other hand, if  $\beta_f(A \rtimes H) \subseteq A$ , then, in particular,  $\beta_f(1 \rtimes x) = 1 \rtimes f(x_2)x_1 \in A$  for all  $x \in H$ . Thus  $f(x_2)x_1$  must be a scalar multiple of  $1_H$  for all  $x \in H$  and applying  $\epsilon$  shows that this scalar is necessarily  $f(x)$ . Thus  $f$  must be a left integral of  $H^*$ .  $\square$

We omit the proof of the next proposition, the first three parts of which follow directly from Lemma 3.3.2 and Theorem 3.3.4, while the fourth has a proof very similar to that of Theorem 3.3.4(2).

**Proposition 3.3.5.** *Suppose that  $\alpha$  is an outer action of the finite-dimensional Hopf algebra  $H$  on an algebra  $A$  and  $B = A \rtimes H$ . Let  $A \subseteq B \subseteq C \subseteq D$  be the iterated basic construction of  $A \subseteq B$ . Then,*

- (1)  $D$  is isomorphic as an algebra over  $A$  to  $A \rtimes H \rtimes H^* \rtimes H$ ,
- (2)  $B' \cap D (= \text{End}({}_B C_B)) = H$  for the natural imbedding of  $H$  in  $D$ ,
- (3)  $\text{Hom}({}_B C_{B,B} B_B)$  is 1-dimensional and is identified in  $H$  as the scalar multiples

of a(ny) non-zero left integral of  $H$ , and

(4)  $A' \cap D (= \text{End}({}_A C_B)) = H^* \rtimes H$  for the natural imbedding of  $H^* \rtimes H$  in  $D$ . □

Note that Proposition 3.3.5(4) implies that the multiplication map  $(A' \cap C) \otimes (B' \cap D) \rightarrow (A' \cap D)$  is an isomorphism. We now show that the crossed product by an outer action of a finite dimensional Hopf algebra recognizes the Hopf algebra. More precisely, we have the following theorem.

**Theorem 3.3.6.** *Let  $H$  be a finite-dimensional Hopf algebra acting outerly on an algebra  $A$ . Then, the isomorphism class of the pair  $A \subseteq A \rtimes H$  determines  $H$  up to isomorphism, i.e., if  $A \subseteq A \rtimes H \cong A \subseteq A \rtimes K$  as pairs of algebras, for some finite dimensional Hopf algebra  $K$  acting outerly on  $A$ , then  $H \cong K$  as Hopf algebras.*

Before beginning the proof we note that by an isomorphism of pairs of algebras  $A \subseteq B$  and  $C \subseteq D$ , we mean an algebra isomorphism from  $B$  to  $D$  that restricts to an isomorphism from  $A$  to  $C$ .

*Proof of Theorem 3.3.6.* Begin with a pair of algebras  $A \subseteq B$  known to be isomorphic to  $A \subseteq A \rtimes H$ . Perform the double basic construction to get the tower  $A \subseteq B \subseteq C \subseteq D$  of algebras. It follows from Theorem 3.3.4(2) and Theorem 3.3.5(2) that  $A' \cap C \cong H^*$  and  $B' \cap D \cong H$  as algebras.

Now, Theorem 3.3.4(3) and Proposition 3.3.5(3) give distinguished 1-dimensional subspaces  $\text{Hom}({}_A B_{A,A} A_A) \subseteq A' \cap C$  and  $\text{Hom}({}_B C_{B,B} B_B) \subseteq B' \cap D$  that are identified with the spaces of left integrals in  $H^*$  and  $H$  respectively.

Pick a non-zero element  $p \in \text{Hom}({}_A B_{A,A} A_A)$ . Since  $p$  corresponds to a left-integral of  $H^*$ , for any  $g \in H^* = A' \cap C$ , we have  $gp = g(1)p$ . Thus we get the map  $g \mapsto g(1) : A' \cap C = H^* \rightarrow k$  - which is the counit  $\epsilon_{H^*}$  of  $H^*$ . Similarly, we get the map  $\epsilon_H : B' \cap D = H \rightarrow k$ .

Finally, given arbitrary  $f \in H^* = A' \cap C$  and  $x \in H = B' \cap D$ , consider  $xf \in A' \cap D$ . Identifying  $H^*$  and  $H$  with their images in  $H^* \rtimes H$ , this is just the element  $(\epsilon \rtimes x)(f \rtimes 1) = \alpha_{x_1}(f) \rtimes x_2 = f_2(x_1)f_1 \rtimes x_2 \in H^* \rtimes H$ . Pulling back this element via the natural isomorphism from  $(A' \cap C) \otimes (B' \cap D)$  to  $(A' \cap D)$  gives the element  $\alpha_{x_1}(f) \otimes x_2 \in H^* \otimes H$ . Now applying  $\epsilon_{H^*} \otimes \epsilon_H$  to this gives  $f(x)$ .

Thus, if  $A \subseteq A \rtimes H \cong A \subseteq A \rtimes K$ , we've seen that there are algebra isomorphisms  $H \rightarrow K$  and  $H^* \rightarrow K^*$  that take the evaluation pairing between  $H$  and  $H^*$  to that between  $K$  and  $K^*$ . This shows that the algebra isomorphisms are bialgebra isomorphisms and therefore also Hopf algebra isomorphisms.  $\square$

### 3.4 The main theorem

We are now ready to state our main result.

**Theorem 3.4.1.** *Let  $H$  be a finite-dimensional Hopf algebra and  $A \subseteq B$  be its derived pair. Then  $B$  is isomorphic, as an algebra over  $A$ , to  $A \rtimes L$  (for some (outer) action of  $L = D(H)^{cop}$  on  $A$ ) and further, up to isomorphism,  $L$  is the only finite-dimensional Hopf algebra with this property.*

We briefly sketch the proof of this theorem before going into the details. We first exhibit  $L = \tilde{D}(H)^{cop} \cong D(H)^{cop}$  (see 3.2) as a subalgebra of  $B$ , show that the multiplication map  $A \otimes L$  to  $B$  is an isomorphism and that  $A$  is stable under the 'adjoint action' of  $L$ . This suffices to see that  $B$  is isomorphic as an algebra over  $A$  to  $A \rtimes L$ . The uniqueness of  $L$  follows from Theorem 3.3.6.

While the following lemma is quite easy to prove, deriving the form of the homomorphism from  $L$  to  $B$  took us the longest time and involved application of the diagrammatics of Jones' planar algebras. Having obtained the formula though, verification is simple.

**Lemma 3.4.2.** *The map  $L \rightarrow B$  defined as the composite map  $L \rightarrow H^{[0,2]} \rightarrow B$  where  $L \rightarrow H^{[0,2]} = H^* \rtimes H \rtimes H^*$  is defined by*

$$f \otimes x \mapsto f_1(Sx_1)f_3 \rtimes Sx_2 \rtimes f_2.$$

*is an injective algebra homomorphism.*

*Proof.* We omit the verification that the map defined is an algebra homomorphism. To see that it is injective, we consider the map  $H^{[0,2]} \rightarrow L$  defined by  $f \rtimes x \rtimes g \mapsto f(1)g_1(S^{-1}x_2)(g_2 \otimes S^{-1}x_1)$  and verify that it is a left inverse.  $\square$

**Remark 3.4.3.** *In particular, Lemma 3.4.2 implies that  $L$  is a subalgebra of  $H^* \rtimes H \rtimes H^* \rtimes H$  which is a matrix algebra of size  $\dim(H)^2$  and also is the tensor square of the Heisenberg double  $H^* \rtimes H$  of  $H^*$ . This is one of the results of [11].*

We will identify  $L$  with its image in  $B$ . Note that under this identification,  $f \otimes 1 \mapsto f_2 \rtimes 1 \rtimes f_1 \in H^{[0,2]}$  and  $\epsilon \otimes x \mapsto Sx \in H^1$ .

**Lemma 3.4.4.** *The multiplication map of  $B$  restricted to  $A \otimes L$  is an isomorphism.*

*Proof.* Given  $\cdots \rtimes x^{-1} \rtimes \epsilon \rtimes 1 \rtimes f^2 \cdots \in A$  and  $f \otimes x \in L$  (identified with  $f_1(Sx_1)f_3 \rtimes Sx_2 \rtimes f_2 \in H^{[0,2]} \subseteq B$ ), their product is computed to be:

$$f_1(Sx_1)f_1^2(Sx_2)f_3(x_1^3)(\cdots \rtimes f^{-2} \rtimes x^{-1} \rtimes f_4 \rtimes Sx_3 \rtimes f_2^2 f_2 \rtimes x_2^3 \rtimes f^4 \rtimes x^5 \rtimes \cdots)$$

Thus, to prove the lemma, it suffices to verify that the map

$$g \otimes y \otimes f \otimes x \mapsto f_1(Sx_1)g_1(Sx_2)f_3(y_1)(f_4 \otimes Sx_3 \otimes g_2 f_2 \otimes y_2)$$

of  $H^* \otimes H \otimes H^* \otimes H$  to itself is a linear isomorphism. We assert, and omit the

straightforward but very computational proof, that the map

$$p \otimes z \otimes q \otimes w \mapsto p_1(Sw_1)q_1(S^{-1}z_2)(q_2Sp_2 \otimes w_2 \otimes p_3 \otimes S^{-1}z_1)$$

is its inverse. □

**Proposition 3.4.5.** *The map  $\gamma : L \rightarrow \text{End}(B)$  given by  $\gamma_{(f \otimes x)}(b) = (f \otimes x)_1 b S((f \otimes x)_2)$  maps  $A$  to itself.*

*Proof.* The map  $\gamma : L \rightarrow \text{End}(B)$  is easily verified to be an action of  $L$  on  $B$  and so it suffices to check for  $f \in H^*$ ,  $x \in H$  and  $a \in A$ , that  $\gamma_{(f \otimes 1)}(a), \gamma_{(\epsilon \otimes x)}(a) \in A$ .

Taking  $a = \cdots \rtimes x^{-3} \rtimes f^{-2} \rtimes x^{-1} \rtimes \epsilon \rtimes 1 \rtimes f^2 \rtimes x^3 \rtimes f^4 \rtimes x^5 \rtimes \cdots$ , we compute

$$\begin{aligned} \gamma_{(f \otimes 1)}(a) &= f_2(x_2^{-1})f_3(Sx_1^3)(\cdots \rtimes f^{-2} \rtimes x_1^{-1} \rtimes \epsilon \rtimes 1 \rtimes f_1 f^2 S f_4 \rtimes x_2^3 \rtimes f^4 \rtimes \cdots), \\ \gamma_{(\epsilon \otimes x)}(a) &= f_1^2(x)(\cdots \rtimes f^{-2} \rtimes x^{-1} \rtimes \epsilon \rtimes 1 \rtimes f_2^2 \rtimes x^3 \rtimes f^4 \rtimes \cdots), \end{aligned}$$

both of which are clearly in  $A$ . □

*Proof of Theorem 4.1.1.* The hypotheses of Lemma 3.1.4 are satisfied by  $A \subseteq B$  and  $L$ , by Lemma 3.4.4 and Proposition 3.4.5. Thus, by its conclusion,  $B$  is isomorphic as an algebra over  $A$  to  $A \rtimes L$ , for some action of  $L$  on  $A$ . This action is outer since  $A \subseteq B$  is irreducible by Proposition 3.1.6. Finally, by Theorem 3.3.6,  $L$  is unique up to isomorphism. □

The result asserted in our abstract is an easy corollary using Lemma 3.2.1.

**Corollary 3.4.6.** *Let  $A \subseteq B$  be the derived pair of  $H^{\text{cop}}$  ( $\cong H^{\text{op}}$ ) for a finite-dimensional Hopf algebra  $H$ . Then  $B$  is isomorphic as an algebra over  $A$  to  $A \rtimes D(H)$  for some outer action of  $D(H)$  on  $A$  and further  $D(H)$  is the only finite-dimensional Hopf algebra with this property.*



# Chapter 4

## Cabling and Drinfeld doubles

Throughout this chapter,  $k$  will be an arbitrary algebraically closed field,  $H = (H, \mu, \eta, \Delta, \epsilon, S)$  a finite-dimensional, semisimple and cosemisimple Hopf algebra over  $k$ , and  $h$  (resp.  $p$ ) will always denote the unique nonzero idempotent integral in  $H$  (resp.  $H^*$ ). Recall that in the previous chapter we have explicitly identified an algebra embedding of  $L = \tilde{D}(H^{cop})$  in  $H^* \rtimes H \rtimes H^*$  (Lemma 3.4.2). Since  $L$  and  $D(H)$  are isomorphic as algebras, this may be regarded as a map of  $P(D(H))_{2,+}$  into  $P(H^*)_{4,+}$ . Such maps are interesting for various reasons. For instance, one such embedding of  $D(H)$  into the tensor square of  $H \rtimes H^*$  is discussed in [11] and used in [12] to construct knot invariants in intrinsically three-dimensional terms.

It is thus a natural question to ask whether the embedding of  $D(H)$  into  $H^* \rtimes H \rtimes H^*$  may be extended to a planar algebra map in some canonical fashion, and it is the affirmative answer to this question that is one of the main results of this chapter. We further show that this planar algebra map is injective and characterise the image of  $P(D(H))$  in  ${}^{(2)}P(H^*)$ .

## 4.1 The planar algebra morphism

The following proposition is the first part of the main result of this chapter.

**Proposition 4.1.1.** *Let  $H$  be a finite-dimensional, semisimple and cosemisimple Hopf algebra over  $k$  of dimension  $n = \delta^2$  with Drinfeld double  $\tilde{D}(H)$ . The map*

$$\tilde{D}(H) \cong P(\tilde{D}(H))_{2,+} \longrightarrow {}^{(2)}P(H^*)_{2,+} = P(H^*)_{4,+} \cong H^* \rtimes H \rtimes H^*$$

*defined by linear extension of  $f \otimes a \mapsto f_1(Sa_1)f_3 \rtimes Sa_2 \rtimes f_2$  extends to a unique planar algebra morphism from  $P(\tilde{D}(H))$  to  ${}^{(2)}P(H^*)$ .*

Before beginning the proof, we recall Lemma 2.5.4 to clarify the isomorphisms occurring in the statement of the proposition. We also remark that we shall write both the Fourier transform maps, one from  $H$  to  $H^*$  given by  $a \rightarrow \delta p_1(a)p_2$  and the other one from  $H^*$  to  $H$  given by  $f \rightarrow \delta f(h_1)h_2$ , as  $F$  with the argument making it clear which is meant.

The idea of the proof of Proposition 4.1.1 is very simple. Since we know a presentation of the planar algebra of  $\tilde{D}(H)$  by generators and relations, in order to define a planar algebra map of  $P(\tilde{D}(H))$  into any planar algebra, it suffices to map the generators to suitable elements in the target planar algebra in such a way that the relations hold.

*Proof of Proposition 4.1.1.* Throughout this proof, we will use  $P$  to denote the planar algebra  $P(\tilde{D}(H))$ .

The map defined in the statement of Proposition 4.1.1 can also be expressed as  $f \otimes a \mapsto (f_2 \rtimes 1 \rtimes f_1)(\epsilon \rtimes S(a) \rtimes \epsilon)$ , as a brief calculation shows. This map is shown pictorially in Figure 4.1. Being bilinear in  $f$  and  $a$ , this map clearly admits a linear extension to a map  $\tilde{D}(H) \longrightarrow P(H^*)_{4,+} = {}^{(2)}P(H^*)_{2,+}$ . Consider its extension to

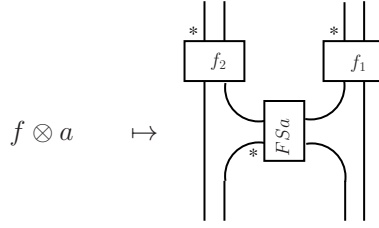

Figure 4.1: Mapping  $\tilde{D}(H)$  to  $P_{4,+}(H^*)$

a planar algebra map from the universal planar algebra on  $L = L_{2,+} = \tilde{D}(H)$  to  ${}^{(2)}P(H^*)$ . We will now check that each of the 8 relations (L), (M), (U), (I), (C), (T), (E), (A) in Figures 2.6 - 2.9 (applied to the Hopf algebra  $\tilde{D}(H)$ ) is in the kernel of this planar algebra map.

**Relation L:** This is a direct consequence of the linearity of the map  $\tilde{D}(H) \rightarrow {}^{(2)}P(H^*)_{2,+} = P(H^*)_{4,+}$  together with the multilinearity of tangle maps.

**Relations M:** The modulus relations for  $P = P(\tilde{D}(H))$  depend on a choice of square root of  $\dim(\tilde{D}(H)) = n^2$  and we will choose  $n$  to be the modulus of  $P$ . Thus the modulus relations for  $P$  assert that  $Z_{T^{0,\pm}}^P(1) = n1_{0,\pm}$  where recall  $T^{0,\pm}$  are the  $(0, \pm)$  tangles with just one internal closed loop and no internal discs and  $1_{0,\pm}$  are the unit elements of  $P_{0,\pm}$ . Pushing this down to  ${}^{(2)}P(H^*)$ , what needs to be verified is that,  $Z_{T^{0,\pm}}^{(2)P(H^*)}(1) = n1_{0,\pm}$  or equivalently that  $Z_{(T^{0,\pm})^{(2)}}^{P(H^*)}(1) = n1_{0,+}$ .

Since the 2-cabled tangle  $(T^{0,\pm})^{(2)}$  is just the  $(0, +)$  tangle with two nested internal closed loops (and no internal discs), the asserted equality is a consequence of (one application of each of) the modulus relations for  $P(H^*)$ .

**Relation U:** This is the equality  $Z_{I_{2,+}^{2,+}}^P(1_{\tilde{D}(H)}) = Z_{U^{2,+}}^P(1)$ , where  $I_{2,+}^{2,+}$  and  $U^{2,+}$  are the identity and unit tangles of colour  $(2, +)$ . In order to push this down to  ${}^{(2)}P(H^*)$ , we note first that  $1_{\tilde{D}(H)} = \epsilon \otimes 1 (= \epsilon \otimes 1_H)$  and that under the map of Figure 4.1 it goes to  $1_{4,+}$  - the unit element of  $P_{4,+}(H^*)$ . This is because  $FS(1) = F(1) = \delta p$  and by use of the integral relation in  $P(H^*)$ .

Thus what needs to be verified is that  $Z_{I_{2,+}^{2,+}}^{(2)P(H^*)}(1_{4,+}) = Z_{U^{2,+}}^{(2)P(H^*)}(1)$  or equiva-

lently that  $Z_{(I_{2,+}^{2,+})^{(2)}}^{P(H^*)}(1_{4,+}) = Z_{(U^{2,+})^{(2)}}^{P(H^*)}(1)$ . The last equality holds since  $(I_{2,+}^{2,+})^{(2)} = I_{4,+}^{4,+}$ ,  $(U^{2,+})^{(2)} = U^{4,+}$  and, by definition,  $1_{4,+} = Z_{U^{4,+}}(1)$ .

**Relation I:** This is the equality  $Z_{I_{2,+}^P}^P(h_{\tilde{D}(H)}) = n^{-1}Z_{E^{2,+}}^P(1)$ , where  $h_{\tilde{D}(H)}$  is the integral in  $\tilde{D}(H)$  and  $E^{2,+}$  is the Jones projection tangle of colour  $(2, +)$  (see Figure 2.1). To push this down to  ${}^{(2)}P(H^*)$ , recall first that  $h_{\tilde{D}(H)} = p \otimes h$ . Under the map of Figure 4.1 this goes to the element of  $P_{4,+}(H^*)$  shown on the left in Figure 4.2,

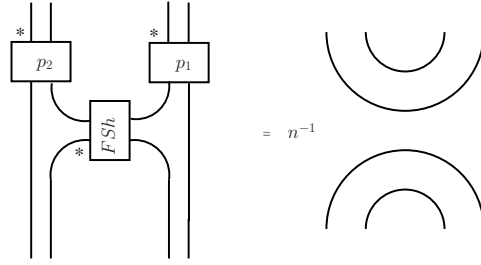

Figure 4.2: Equality to be verified in  $P_{4,+}(H^*)$

which needs to be shown to be equal to  $n^{-1}Z_{E^{2,+}}^{(2)P(H^*)}(1) = n^{-1}Z_{(E^{2,+})^{(2)}}^{P(H^*)}(1)$ , which is the element of  $P_{4,+}(H^*)$  shown on the right in Figure 4.2.

We prove this as follows. First note that  $FS(h) = F(h) = \delta p_1(h)p_2 = \delta p(h)\epsilon = \delta^{-1}\epsilon$ . Now applying the unit relation in  $P(H^*)$  we reduce the element on the left side of Figure 4.2 to that on the left side in Figure 4.3.

Then we calculate in  $P(H^*)$  as follows:

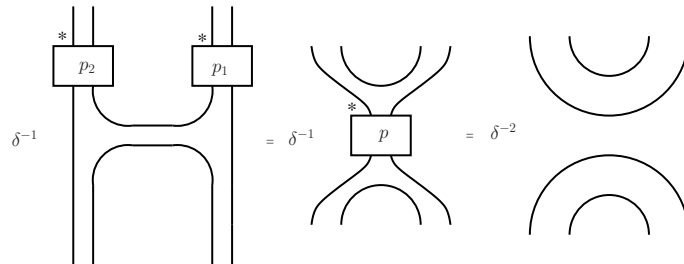

Figure 4.3: Computation in  $P(H^*)$

The first equality in Figure 4.3 follows from the exchange and antipode relations in  $P(H^*)$  together with the fact that  $Sp = p$  and the Hopf algebra identity  $p_1 \otimes$

$p_2 = p_2 \otimes p_1$  (which essentially expresses the traciality of  $p$ ), while the second equality follows from the integral relation. Now, comparison with the previous step immediately yields the equality expressed in Figure 4.2, thus verifying Relation (I).

**Relation C:** Recalling that the counit of  $\tilde{D}(H)$  is given by  $1 \otimes \epsilon$ , the verification that Relation C is in the kernel of the planar algebra map from  $P$  to  ${}^{(2)}P(H^*)$  is easily seen to be equivalent to the truth of the equation of Figure 4.4 holding in  $P(H^*)$ . To prove this, observe that since the trace and antipode relations in  $P(H^*)$

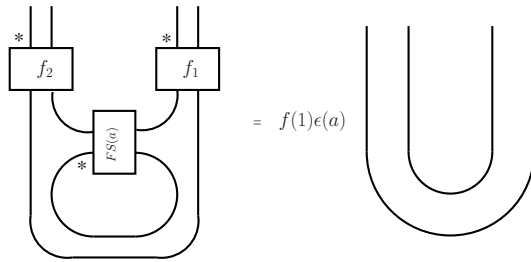

Figure 4.4: Relation C

simplify the looped  $FS(a)$  to  $\delta F(a)(h) = \delta^2 p(Sah) = \epsilon(a)$ . Now  $f_2 S f_1 = f(1)\epsilon$ , so the required equality follows using Relation  $U$ .

**Relation T:** Recalling that  $p_{\tilde{D}(H)} = h \otimes p$ , the verification that Relation T is in the kernel of the planar algebra map from  $P$  to  ${}^{(2)}P(H^*)$  is seen to be equivalent to the truth of the equation of Figure 4.5 holding in  $P(H^*)$ . The left hand side of Figure

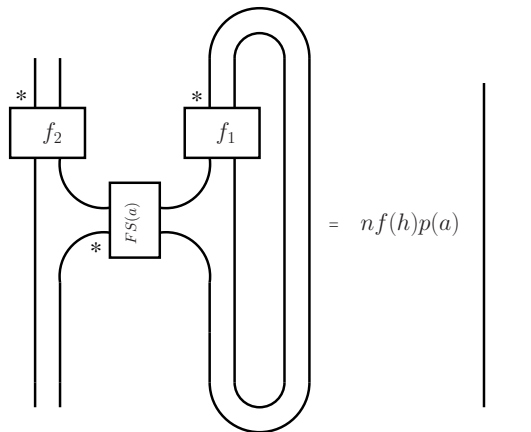

Figure 4.5: Relation T

4.5 simplifies, using the trace and counit relations in  $P(H^*)$ , to  $\delta f_1(h)FS(a)(1)f_2 =$

$\delta^2 p(a) f_1(h) f_2 = np(a) f(h)$ , as needed.

**Relation E:** This is equivalent to two relations - one for multiplication and the other for comultiplication. These are shown in Figure 4.6. To prove that the multiplication

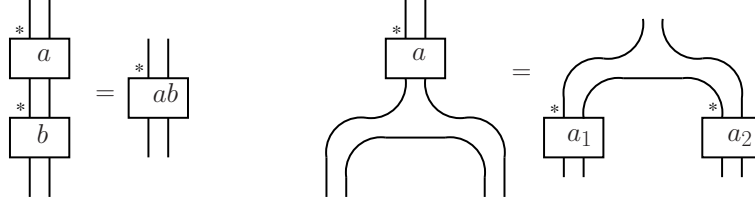

Figure 4.6: Multiplication and comultiplication relations

relation is in the kernel, a little thought shows that it suffices to verify the equality of Figure 4.7 in  $P(H^*)$ . Using the exchange relation in  $P(H^*)$  twice, the equality in

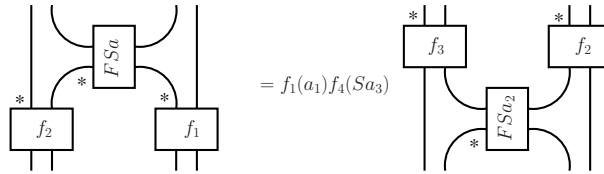

Figure 4.7: Equality to be verified for the multiplication relation

Figure 4.7 is equivalent to the Hopf algebraic identity:

$$f_1 \otimes f_2 \otimes FS(a) = f_1(a_1) f_6(Sa_3) f_3 \otimes f_4 \otimes f_5 SF(a_2) S f_2.$$

To see this, it certainly suffices to see that

$$f \otimes FS(a) = f_1(a_1) f_5(Sa_3) f_3 \otimes f_4 SF(a_2) S f_2.$$

Evaluating both sides on an arbitrary element  $x \otimes y \in H \otimes H$ , we need to verify the equality

$$f(x) FS(a)(y) = f_1(a_1) f_5(Sa_3) f_3(x) (f_4 SF(a_2) S f_2)(y).$$

The right hand side of the above equation may be written as:

$$\begin{aligned}
RHS &= f_1(a_1)f_5(Sa_3)f_3(x)f_4(y_1)SF(a_2)(y_2)Sf_2(y_3) \\
&= \delta f_1(a_1)f_5(Sa_3)f_3(x)f_4(y_1)p_1(Sa_2)p_2(y_2)Sf_2(y_3) \\
&= \delta f_1(a_1)f_5(Sa_3)f_3(x)(f_4p_2Sf_2)(y)p_1(Sa_2) \\
&= \delta f_1(a_1)f_5(Sa_3)f_3(x)p_2(y)(Sf_4p_1f_2)(Sa_2) \\
&= \delta f_1(a_1)f_5(Sa_5)f_3(x)p_2(y)Sf_4(Sa_4)p_1(Sa_3)f_2(Sa_2) \\
&= \delta f(a_1Sa_2xa_4Sa_5)p_2(y)p_1(Sa_3) \\
&= \delta f(x)p(Say),
\end{aligned}$$

which clearly agrees with the left hand side, finishing the proof of the multiplication relation.

Checking that the comultiplication relation is in the kernel is seen to be equivalent to the identity of Figure 4.8 holding in  $P(H^*)$ . This easily reduces to verifying

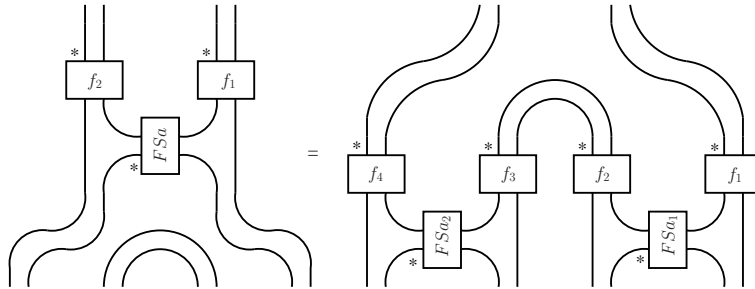

Figure 4.8: Equality to be verified for the comultiplication relation

the relation of Figure 4.9. We leave this pleasant verification to the reader.

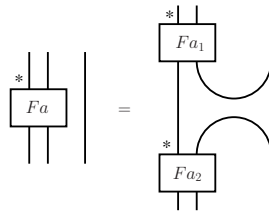

Figure 4.9: Equivalent equality to be verified

**Relation A:** The easiest way to see that the antipode relation is in the kernel of the planar algebra map from  $P$  to  ${}^{(2)}P(H^*)$  is to appeal to the already proved multiplication relation. Since  $S$  is an anti-homomorphism as is the 2-rotation on 2-boxes, compatibility with multiplication immediately reduces to checking the antipode relation on an algebra generating set of  $\tilde{D}(H)$ . These may be chosen to be  $f \otimes 1$  and  $a \otimes \epsilon$ , and on elements of this kind, the antipode relation is trivial to verify.  $\square$

## 4.2 Injectivity

**Proposition 4.2.1.** *The planar algebra morphism  $P(\tilde{D}(H)) (=P)$  to  ${}^{(2)}P(H^*)$  defined in Proposition 4.1.1 is injective.*

*Proof.* Let  $\Psi : P \rightarrow {}^{(2)}P(H^*)$  denote the planar algebra morphism of Proposition 4.1.1, which is a collection of maps  $\Psi_{k,\epsilon} : P_{k,\epsilon} \rightarrow ({}^{(2)}P(H^*))_{k,\epsilon} = P_{2k,+}(H^*)$  for each colour  $(k, \epsilon)$ . To see that each of these is injective, it suffices to check this when either  $k = 0$  or when  $\epsilon = 1$  (since the one-rotation tangles for  $k > 0$  give isomorphisms). The cases when  $k = 0$  (and  $\epsilon = \pm 1$ ) are obvious since both sides are naturally isomorphic to  $k$  with the  $\Psi_{0,\pm}$ 's reducing to the identity map under these isomorphisms. Also,  $\Psi_{1,+}$  takes  $1_1 \in P_{1,+}$  to  $1_2 \in P_{2,+}(H^*)$ , and is therefore injective.

For  $k \geq 2$  (and  $\epsilon = 1$ ) consider the family of tangles  $X^{k,+}$  with  $k - 1$  internal boxes of colour  $(2, +)$  defined inductively as in Figure 4.10. It is easy to see that  $X^{k,+} \in \mathcal{T}(k, +)$ . Thus  $Z_{X^{k,+}}^P : (\tilde{D}(H))^{\otimes(k-1)} \rightarrow P_{k,+}$  is an isomorphism by virtue of Lemma 2.5.3, and to show that  $\Psi_{k,+}$  is injective it suffices to see that  $\Psi_{k,+} \circ Z_{X^{k,+}}^P$  is injective.

Since  $\Psi$  is a planar algebra morphism defined by the extension of the map of Figure 4.1, it follows easily that  $\Psi_{k,\epsilon} \circ Z_{X^{k,+}}^P((f^1 \otimes x^1) \otimes (f^2 \otimes x^2) \otimes \cdots \otimes (f^{(k-1)} \otimes x^{(k-1)}))$



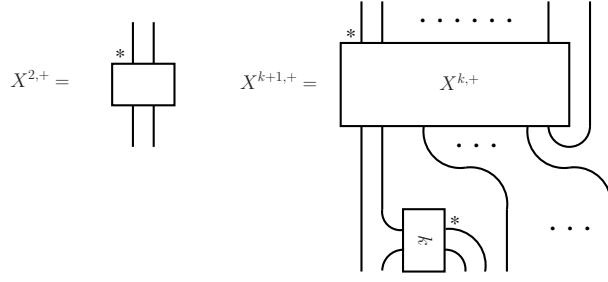

Figure 4.10: Inductive definition of  $X^{k+1,+}$

is given by the element of  $P_{2k,+}(H^*)$  shown in Figure 4.11. Some manipulation with

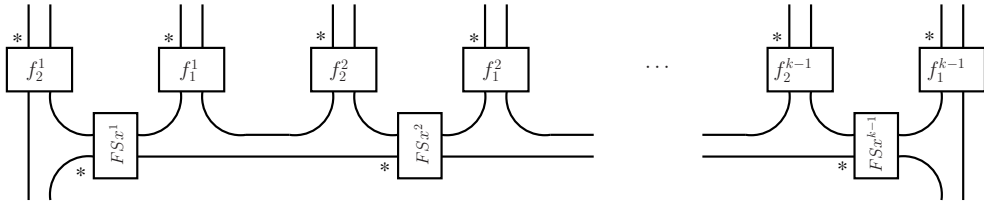

Figure 4.11:  $\Psi_{k,\epsilon} \circ Z_{X^{k,+}}^P((f^1 \otimes x^1) \otimes (f^2 \otimes x^2) \otimes \dots \otimes (f^{(k-1)} \otimes x^{(k-1)}))$

the exchange relation in  $P(H^*)$  shows that this element is also equal to  $Z_{S^{2k,+}}^{P(H^*)}(f_2^1 \otimes FSx^1Sf_3^2 \otimes f_1^1Sf_2^2 \otimes f_4^2FSx^2Sf_3^3 \otimes f_1^2Sf_2^3 \otimes \dots \otimes f_4^{k-2}FSx^{k-2}Sf_3^{k-1} \otimes f_1^{k-2}Sf_2^{k-1} \otimes f_4^{k-1}FSx^{k-1} \otimes f_1^{k-1})$  where  $S^{2k,+}$  is the  $(2k,+)$  tangle with  $2k-1$  internal boxes of colour  $(2,+)$  shown in Figure 4.12. Now observe that  $S^{2k,+}$  is in  $\mathcal{T}(2k,+)$  and thus

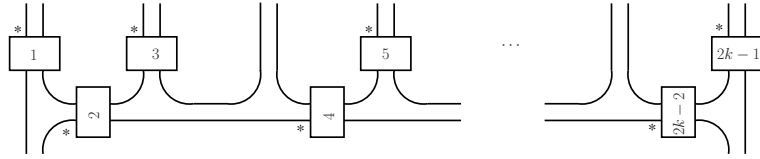

Figure 4.12: The tangle  $S^{2k,+}$

the injectivity statement desired reduces to the Hopf algebra statement: for every  $k \geq 2$  the map, say  $\eta_k : (H^* \otimes H)^{\otimes(k-1)} \rightarrow (H^*)^{\otimes(2k-1)}$  defined by

$$\begin{aligned}
 & f^1 \otimes x^1 \otimes f^2 \otimes x^2 \otimes \dots \otimes f^{(k-1)} \otimes x^{(k-1)} \xrightarrow{\eta_k} \\
 & f_2^1 \otimes FSx^1Sf_3^2 \otimes f_1^1Sf_2^2 \otimes f_4^2FSx^2Sf_3^3 \otimes f_1^2Sf_2^3 \otimes \dots \\
 & \dots \otimes f_4^{k-2}FSx^{k-2}Sf_3^{k-1} \otimes f_1^{k-2}Sf_2^{k-1} \otimes f_4^{k-1}FSx^{k-1} \otimes f_1^{k-1}
 \end{aligned}$$

is injective. It is this statement that we will prove by induction on  $k$ .

The basis case when  $k = 2$  asserts that  $\eta_2$  defined by  $\eta_2(f^1 \otimes x^1) = f_2^1 \otimes FSx^1 \otimes f_1^1$  is injective which is clear. For the inductive step, assume that  $\eta_k$  is injective and observe that with the linear map  $\theta : H^* \otimes H \otimes H^* \otimes H^* \rightarrow (H^*)^{\otimes 4}$  defined by  $\theta(f \otimes x \otimes k \otimes q) = f_2 \otimes FSxSk_2 \otimes f_1Sk_1 \otimes k_3q$ , a short calculation shows that  $\eta_{k+1} = (\theta \otimes id^{\otimes (2k-3)}) \circ (id \otimes id \otimes \eta_k)$ . Thus to show  $\eta_{k+1}$  is injective, it suffices to see that  $\theta$  is injective.

Finally, a lengthy but complete routine calculation shows that the map  $f \otimes g \otimes k \otimes q \mapsto f_4 \otimes F(gSk_1f_3) \otimes Sk_3f_1 \otimes Sf_2k_2q$  is a (right inverse and hence) inverse of  $\theta$ , completing the proof of the inductive step and hence, of the proposition.  $\square$

A much simpler proof of injectivity has been suggested by Prof. Shamindra Kumar Ghosh which relies on the following lemma.

**Lemma 4.2.2.** *Let  $P$  and  $Q$  be two connected planar algebras with the same non-zero modulus such that the trace tangles  $TR_{k,\epsilon}^{0,\epsilon}$  (see Figure 2.1 for the definition) yield non-degenerate traces on  $P_{k,\epsilon}$  for each color  $(k, \epsilon)$ . Any planar algebra morphism from  $P$  to  $Q$  is then injective.*

*Proof.* Let  $f = \{f_{k,\epsilon} : P_{k,\epsilon} \rightarrow Q_{k,\epsilon}\}$  be a planar algebra morphism from  $P$  to  $Q$ . Given a non-zero element  $x$  in  $P_{k,\epsilon}$ , by non-degeneracy of the trace, there exists an element  $y$  in  $P_{k,\epsilon}$  such that  $Z_{TR_{k,\epsilon}^{0,\epsilon}}^P(xy) \neq 0$ . Since  $P$  and  $Q$  are both connected, the maps  $f_{0,\epsilon} : P_{0,\epsilon} \rightarrow Q_{0,\epsilon}$  are isomorphisms and so  $f_{0,\epsilon}(Z_{TR_{k,\epsilon}^{0,\epsilon}}^P(xy)) \neq 0$ . But  $f_{0,\epsilon}(Z_{TR_{k,\epsilon}^{0,\epsilon}}^P(xy)) = Z_{TR_{k,\epsilon}^{0,\epsilon}}^Q(f_{k,\epsilon}(x)f_{k,\epsilon}(y))$ . Thus  $f_{k,\epsilon}(x) \neq 0$ .  $\square$

*Second proof of Proposition 4.2.1.* This follows directly from an application of Lemma 4.2.2.  $\square$

### 4.3 Characterisation of the image

Fix  $k \geq 2$ . Consider the (algebra) maps  $\alpha, \beta : H \rightarrow \text{End}(P(H^*)_{2k,+})$  defined for  $x \in H$  and  $X \in P(H^*)_{2k,+}$  by Figure 4.13.

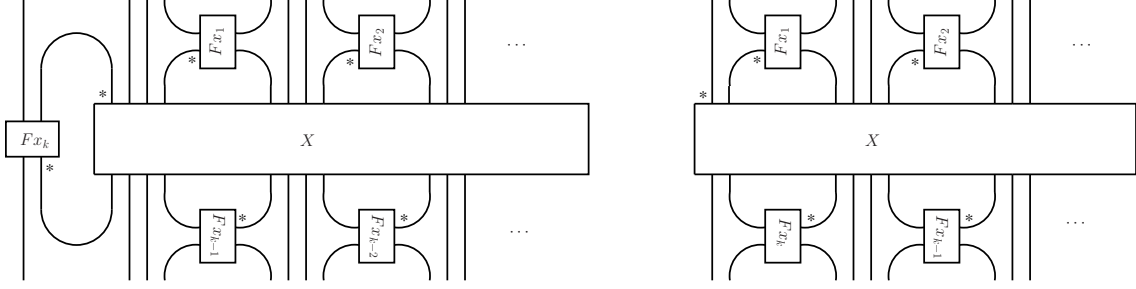

Figure 4.13: Definition of  $\alpha_x(X)$  and  $\beta_x(X)$

The main result of this section is the following proposition. We will use the notation  $Q$  to denote the planar subalgebra of  $({}^2)P(H^*)$  that is the image of  $P = P(\tilde{D}(H))$ . Thus  $Q_{k,\pm} \subseteq P(H^*)_{2k,+}$ .

**Proposition 4.3.1.** *For every  $k \geq 2$ ,*

$$Q_{k,+} = \{X \in P(H^*)_{2k,+} : \alpha_h(X) = X\},$$

$$Q_{k,-} = \{X \in P(H^*)_{2k,+} : \beta_h(X) = X\}.$$

We pave the way for a proof of this proposition by giving an alternate description of the fixed points under  $\alpha_h$ . We will need some notation. For  $x \in H$ , let  $\theta_k(x)$  denote the element of  $P(H^*)_{4k,+}$  depicted in Figure 4.14. For  $X \in P(H^*)_{4k,+}$  (resp.  $P(H^*)_{4k+2,+}$ ) let  $\tilde{X} \in P(H^*)_{4k+4,+}$  denote the element on the left (resp. right) in Figure 4.15.

**Lemma 4.3.2.** *For  $X \in P(H^*)_{4k,+}$  or  $X \in P(H^*)_{4k+2,+}$ , the following conditions are equivalent:*

- (1)  $\alpha_h(X) = X$ , and

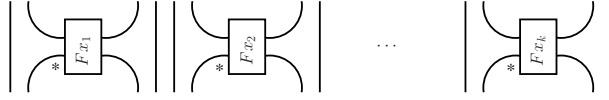

Figure 4.14: Definition of  $\theta_k(x)$



Figure 4.15: Definition of  $\tilde{X}$

(2)  $\tilde{X}$  commutes with  $\theta_{k+1}(x)$  for all  $x \in H$ .

*Proof.* We prove the equivalence of the conditions only for  $X \in P(H^*)_{4k,+}$  leaving the case  $X \in P(H^*)_{4k+2,+}$  for the reader. Suppose that (1) holds so that  $\alpha_h(X) = X$ . Then, using the definitions of  $\alpha_x(X)$  and of  $\tilde{X}$ , we have that  $\tilde{X}$  is given by Figure 4.16. With a little manipulation and using traciality of  $h$ , so that  $h_1 \otimes h_2 \otimes \cdots \otimes h_{2k} =$

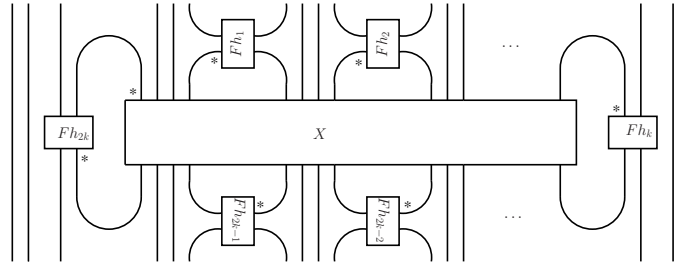

Figure 4.16:  $\tilde{X}$  when  $X \in P(H^*)_{4k,+}$  and  $\alpha_h(X) = X$

$h_{2k} \otimes h_1 \otimes h_2 \otimes \cdots \otimes h_{2k-1}$ , we see that  $\tilde{X}$  is also given by Figure 4.17 below. Thus,  $\tilde{X} = \theta_{k+1}(h_1)\tilde{X}\theta_{k+1}(Sh_2)$ . Hence, for any  $x \in H$ ,  $\tilde{X}\theta_{k+1}(x) = \theta_{k+1}(h_1)\tilde{X}\theta_{k+1}(Sh_2x) = \theta_{k+1}(xh_1)\tilde{X}\theta_{k+1}(Sh_2) = \theta_{k+1}(x)\tilde{X}$ , so that (2) is verified to hold. Conversely suppose that (2) holds for  $X \in P_{4k,+}$ . It follows that the element in Figure 4.17 equals  $\tilde{X}$  and hence also the element of Figure 4.16. This then implies that  $\alpha_h(X) = X$ , proving (1) as needed.  $\square$

Next, we need some preliminary commutativity statements.

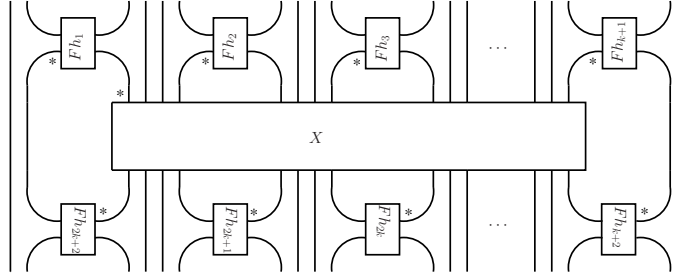
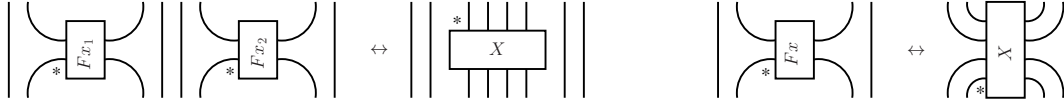

Figure 4.17: Equivalent form of  $\tilde{X}$  when  $X \in P(H^*)_{4k,+}$  and  $\alpha_h(X) = X$

**Lemma 4.3.3.** *The following two commutativity statements hold for all  $x \in H$  and all  $X \in Q_{2,+}$ .*



*Proof.* To prove the first commutativity relation, from the form of a general generator of  $Q_{2,+}$  in Figure 4.1, it suffices to see that the commutativity in Figure 4.18 holds. To see this, note that calculation - see the pictorial rule for multiplication in

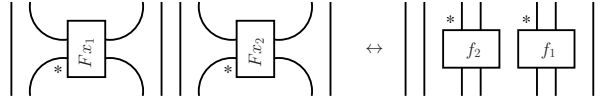

Figure 4.18: Equivalent form of the first commutativity relation

iterated cross products in [2] - shows that the elements  $\epsilon \times 1 \times f_2 \times 1 \times f_1 \times 1$  and  $\epsilon \times x_1 \times \epsilon \times 1 \times \epsilon \times x_2$  of  $H^* \times H \times H^* \times H \times H^* \times H$  commute for all  $f \in H^*$  and  $x \in H$ . Now applying the isomorphisms of Lemma 2.5.4 (to  $P(H^*)$ ) proves the desired commutativity.

As for the second commutativity relation, again from the form of a general generator of  $Q_{2,+}$ , it is easily seen to be equivalent to the equation in Figure 4.19 holding for all  $f \in H^*$  and  $x, a \in H$ .

Setting  $Fx = g$ , this is equivalent to verifying the Hopf algebraic identity  $f_2 \otimes$

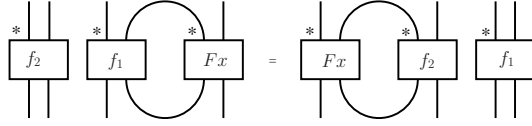

Figure 4.19: Equivalent form of the second commutativity relation

$(f_1 S g_1)(h)g_2 = (f_2 S g_2)(h)g_1 \otimes f_1$ . Evaluate both sides on  $a \otimes b$  to get the equivalent identity  $h_1 a \otimes S h_2 b = b h_1 \otimes a S h_2$  - which is easy to see.  $\square$

*Proof of Proposition 4.3.1.* We first prove the characterisation of  $Q_{k,+}$ . Since  $Q$  is the image of  $P(\tilde{D}(H))$ , it follows from Lemma 2.5.4 that any element  $X \in Q_{2k,+} \subseteq P(H^*)_{4k,+}$  is of the form shown in Figure 4.20, where there are  $2k - 1$  4-boxes and

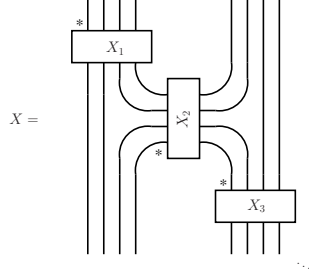

Figure 4.20: Form of  $X \in Q_{2k,+}$

$X_1, X_2, \dots, X_{2k-1} \in Q_{2,+}$ . It now follows easily from Lemma 4.3.3 that  $\tilde{X}$  commutes with  $\theta_{k+1}(x)$  for all  $x \in H$ . Similarly, if  $X \in Q_{2k+1,+} \subseteq P(H^*)_{4k+2,+}$ , then too  $\tilde{X}$  commutes with  $\theta_{k+1}(x)$  for all  $x \in H$ . An appeal to Lemma 4.3.2 now shows that  $Q_{k,+} \subseteq \{X \in P(H^*)_{2k,+} : \alpha_h(X) = X\}$ .

To prove the reverse inclusion, it suffices by Proposition 4.2.1 to see that  $\dim(\{X \in P(H^*)_{2k,+} : \alpha_h(X) = X\}) \leq n^{2k-2}$ . Consider the tangle  $V^{2k,+}$  of Figure 4.21. Note that  $V^{2k,+} \in \mathcal{T}(2k,+)$  and hence induces a linear isomorphism from  $(H^*)^{\otimes(2k-1)} \rightarrow P(H^*)_{2k,+}$ . Further, we see that

$$\begin{aligned} \alpha_h(Z_{V^{2k,+}}(F a^1 \otimes F a^2 \otimes \dots \otimes F a^{2k-1})) = \\ F(h_1 a^1) \otimes F a^2 \otimes F(h_2 a^3) \otimes F a^4 \otimes \dots \otimes F a^{2k-2} \otimes F(h_k a^{2k-1}). \end{aligned}$$

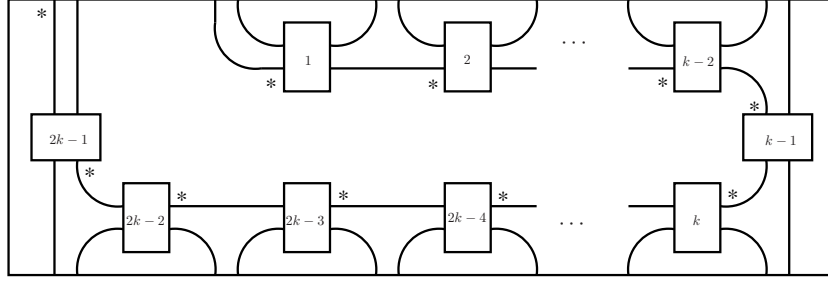

Figure 4.21: The tangle  $V^{2k,+}$

Thus it suffices to see that  $\dim(\{a^1 \otimes \cdots \otimes a^{2k-1} \in H^{\otimes(2k-1)} : a^1 \otimes \cdots \otimes a^{2k-1} = h_1 a^1 \otimes a^2 \otimes h_2 a^3 \otimes a^4 \otimes \cdots \otimes a^{2k-2} \otimes h_k a^{2k-1}\}) \leq n^{2k-2}$  or equivalently that  $\dim(\{x^1 \otimes \cdots \otimes x^k \in H^{\otimes k} : x^1 \otimes \cdots \otimes x^k = h_1 x^1 \otimes h_2 x^2 \otimes \cdots \otimes h_k x^k\}) \leq n^{k-1}$ . Now observe that if  $x^1 \otimes \cdots \otimes x^k = h_1 x^1 \otimes h_2 x^2 \otimes \cdots \otimes h_k x^k$ , then

$$\begin{aligned}
x^1 \otimes \cdots \otimes x^k &= h_1 x^1 \otimes h_2 x^2 \otimes \cdots \otimes h_k x^k \\
&= h_1 x^1 \otimes \Delta_{k-1}(h_2)(x^2 \otimes \cdots \otimes x^k) \\
&= h_1 \otimes \Delta_{k-1}(h_2 S x^1)(x^2 \otimes \cdots \otimes x^k) \\
&= h_1 \otimes h_2 S x_{k-1}^1 x^2 \otimes \cdots \otimes h_k S x_1^1 x^k
\end{aligned}$$

This is clearly in the image of the map  $H^{\otimes k-1} \rightarrow H^{\otimes k}$  given by  $z^1 \otimes \cdots \otimes z^{k-1} \mapsto h_1 \otimes h_2 z^2 \otimes \cdots \otimes h_k z^{k-1}$  and so the required dimension estimate follows.

Now note that,  $X \in Q_{k,-} \Leftrightarrow Z_R(X) \in Q_{k,+}$  (where  $R$  is the one-rotation tangle on  $(k, -)$  boxes, since  $Q$  is a planar subalgebra of  $({}^2P(H^*))$ ). The action of  $R$  on  $Q_{k,-}$  is given by the two-rotation tangle on  $P(H^*)_{2k,+}$ . Now the asserted characterisation of  $Q_{k,-}$  follows from that of  $Q_{k,+}$ .  $\square$

## 4.4 The main theorem

We collect the results of the previous statements into a single main theorem.

**Theorem 4.4.1.** *Let  $H$  be a finite-dimensional, semisimple and cosemisimple Hopf algebra over  $k$  of dimension  $n = \delta^2$  with Drinfeld double  $\tilde{D}(H)$ . The map*

$$P(\tilde{D}(H))_{2,+} \longrightarrow {}^{(2)}P(H^*)_{2,+}$$

*defined in Proposition 4.1.1 extends to an injective planar algebra morphism  $P(\tilde{D}(H)) \longrightarrow {}^{(2)}P(H^*)$  whose image  $Q$  is characterised as follows:  $Q_{k,+}$  (resp.  $Q_{k,-}$ ) is the set of all  $X \in P_{2k,+}$  such the element on the left (resp. right) in Figure 4.22 equals  $X$ .*

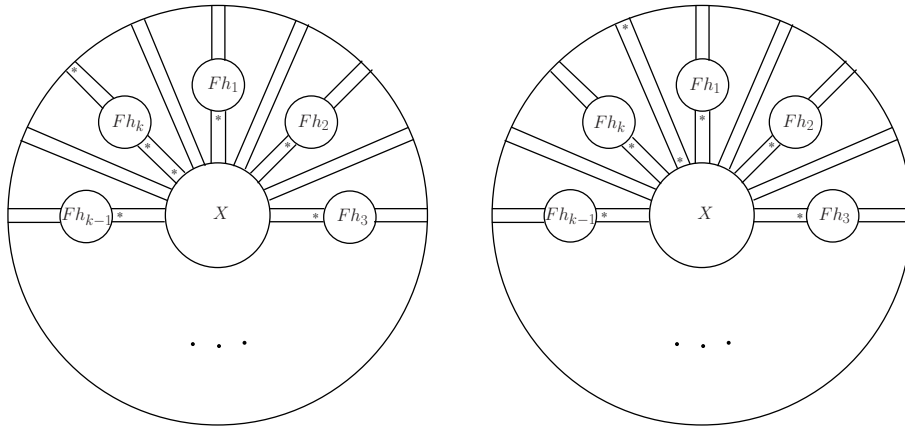

Figure 4.22: Characterisation of the image

*Proof.* This follows from Propositions 4.1.1, 4.2.1 and 4.3.1, after observing that Figures 4.13 and 4.22 are equivalent. □

**Remark 4.4.2.** *It is worth noting that the main theorem above also allows us to conclude that there is an explicitly characterised planar subalgebra of  ${}^{(2)}P(H^{op})$  that is isomorphic to  $P(\tilde{D}(H))$ . This is because  $\tilde{D}(H)$  and  $\tilde{D}((H^{op})^*)$  are isomorphic.*



# Bibliography

- [1] Sorin Dăscălescu, Constantin Năstăsescu, and Şerban Raianu. *Hopf algebras*, volume 235 of *Monographs and Textbooks in Pure and Applied Mathematics*. Marcel Dekker, Inc., New York, 2001. An introduction.
- [2] Sandipan De and Vijay Kodiyalam. Note on infinite iterated crossed products of Hopf algebras and the Drinfeld double. *J. Pure Appl. Algebra*, 219(12):5305–5313, 2015.
- [3] Yukio Doi and Mitsuhiro Takeuchi. Cleft comodule algebras for a bialgebra. *Comm. Algebra*, 14(5):801–817, 1986.
- [4] Pavel Etingof and Shlomo Gelaki. On finite-dimensional semisimple and cosemisimple Hopf algebras in positive characteristic. *Internat. Math. Res. Notices*, (16):851–864, 1998.
- [5] Shamindra Kumar Ghosh. Planar algebras: a category theoretic point of view. *J. Algebra*, 339:27–54, 2011.
- [6] S. Jijo. *Planar algebra associated to the Asymptotic inclusion of a Kac algebra subfactor*. PhD thesis, Chennai Mathematical Institute, 2008.
- [7] S. Jijo and V. S. Sunder. Kac algebras, quantum doubles and planar algebras. In *Symmetry in mathematics and physics*, volume 490 of *Contemp. Math.*, pages 97–104. Amer. Math. Soc., Providence, RI, 2009.

- [8] Vaughan F. R. Jones. Planar algebras. *New Zealand J. Math.* To appear, arXiv:math/9909027.
- [9] Lars Kadison. Hopf algebroids and Galois extensions. *Bull. Belg. Math. Soc. Simon Stevin*, 12(2):275–293, 2005.
- [10] Lars Kadison and Dmitri Nikshych. Hopf algebra actions on strongly separable extensions of depth two. *Adv. Math.*, 163(2):258–286, 2001.
- [11] R. M. Kashaev. The Heisenberg double and the pentagon relation. *Algebra i Analiz*, 8(4):63–74, 1996.
- [12] R. M. Kashaev.  $R$ -matrix knot invariants and triangulations. In *Interactions between hyperbolic geometry, quantum topology and number theory*, volume 541 of *Contemp. Math.*, pages 69–81. Amer. Math. Soc., Providence, RI, 2011.
- [13] Christian Kassel. *Quantum groups*, volume 155 of *Graduate Texts in Mathematics*. Springer-Verlag, New York, 1995.
- [14] Louis H. Kauffman and David E. Radford. On two proofs for the existence and uniqueness of integrals for finite-dimensional Hopf algebras. In *New trends in Hopf algebra theory (La Falda, 1999)*, volume 267 of *Contemp. Math.*, pages 177–194. Amer. Math. Soc., Providence, RI, 2000.
- [15] Vijay Kodiyalam and V. S. Sunder. On Jones’ planar algebras. *J. Knot Theory Ramifications*, 13(2):219–247, 2004.
- [16] Vijay Kodiyalam and V. S. Sunder. The planar algebra of a semisimple and cosemisimple Hopf algebra. *Proc. Indian Acad. Sci. Math. Sci.*, 116(4):443–458, 2006.
- [17] H. F. Kreimer and M. Takeuchi. Hopf algebras and Galois extensions of an algebra. *Indiana Univ. Math. J.*, 30(5):675–692, 1981.

- [18] Greg Kuperberg. Noninvolutory Hopf algebras and 3-manifold invariants. *Duke Math. J.*, 84(1):83–129, 1996.
- [19] Shahn Majid. *A quantum groups primer*, volume 292 of *London Mathematical Society Lecture Note Series*. Cambridge University Press, Cambridge, 2002.
- [20] Susan Montgomery. *Hopf algebras and their actions on rings*, volume 82 of *CBMS Regional Conference Series in Mathematics*. Published for the Conference Board of the Mathematical Sciences, Washington, DC; by the American Mathematical Society, Providence, RI, 1993.
- [21] D. S. Passman and Declan Quinn. Involutory Hopf algebras. *Trans. Amer. Math. Soc.*, 347(7):2657–2668, 1995.
- [22] David E. Radford. The group of automorphisms of a semisimple Hopf algebra over a field of characteristic 0 is finite. *Amer. J. Math.*, 112(2):331–357, 1990.
- [23] Moss E. Sweedler. *Hopf algebras*. Mathematics Lecture Note Series. W. A. Benjamin, Inc., New York, 1969.